

# WICONA

## System data sheets



# » WICONA

## System data sheets

All key product features for each application at a glance: the WICONA system data sheets offer you all critical information about all WICONA series in a complete, clear and structured overview.

These product data sheets are updated regularly, with the most recent version always available as PDF for download on our website.

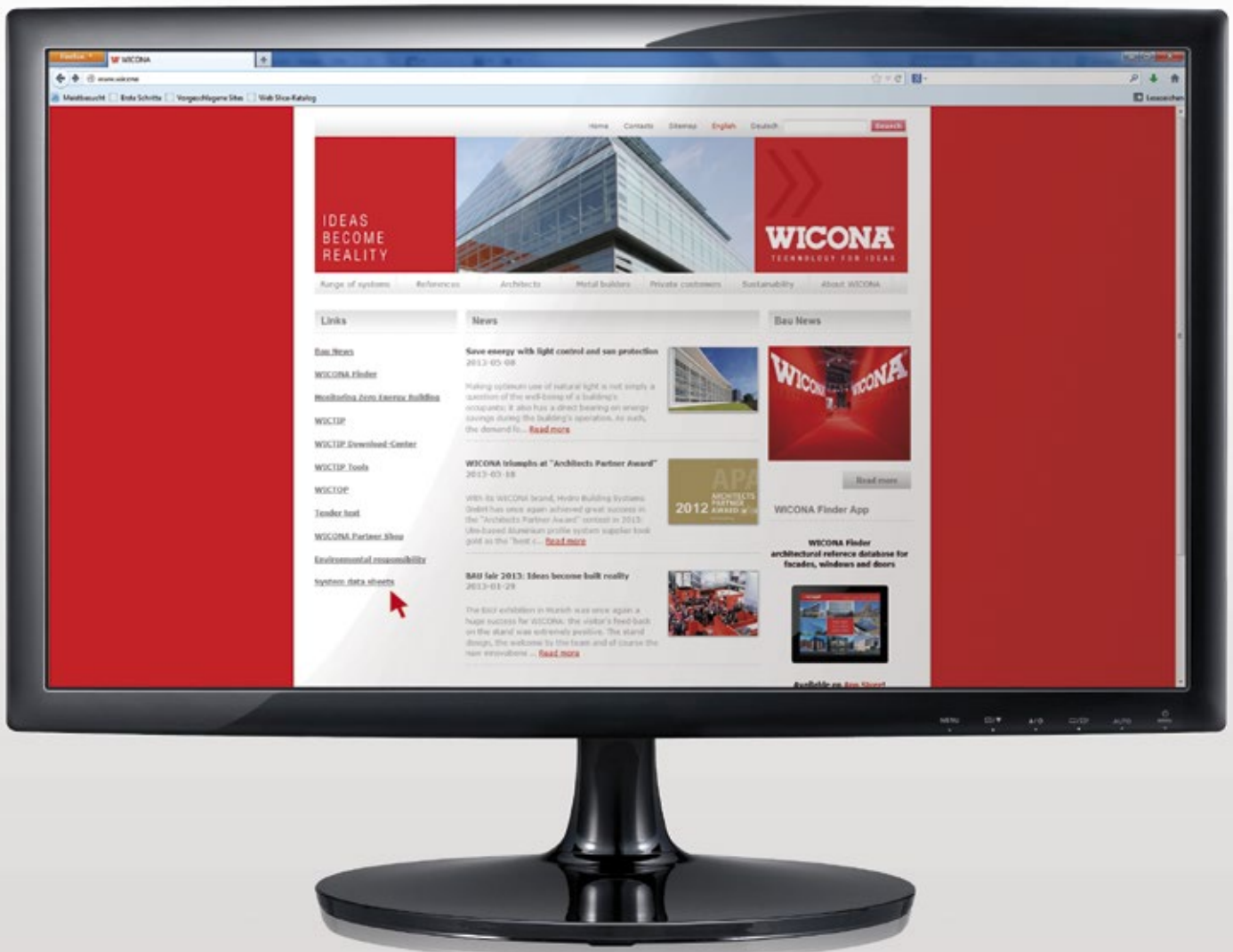

## Content

**Curtain walling WICTEC**

**Integration sashes WICLINE**

**Windows WICLINE**

**Doors WICSTYLE**

**Sliding systems WICSLIDE**

**Solar shading systems WICSOLAIRE**

**You can find more comprehensive support tools for your project planning and tendering on our website.**

- Tender texts as word templates
- System sections in .dwg und .dxf format
- System data sheets in PDF format
- Reference projects worldwide in WICONA FINDER or on our iPad App

Please note: the application possibilities and the availability of the product series may be different depending on the country. Please ask your local WICONA sales office (addresses see last page) for details.



# WICTEC 50

## Stick system curtain wall



WICTEC 50 is the basic version of the stick system curtain wall, with an extra-narrow face width of 50 mm, inside and outside. The unique flexibility is demonstrated by the various system variants and enhancement options, all of which are feasible with minor additions to the system and without compromising on appearance.

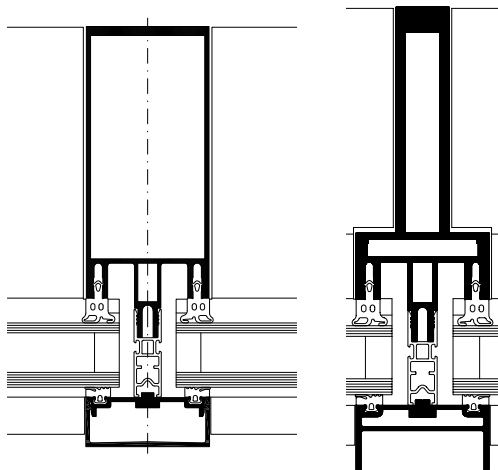

### System test results / CE product pass in accordance with DIN EN 13830

Air permeability:	Class AE
Watertightness:	RE 1200
Resistance to wind load:	2000 / -3200 Pa, security 3000 / -4800 Pa
Sound insulation:	$R_w (C; C_{tr}) = 47 (-1; -4)$ dB
Impact resistance:	Class E5 / I5
Burglar resistance:	RC1N, RC2N, RC2, RC3
Bullet resistance:	FB4
Quality assurance:	Certified according to ISO 9001:2008

### Technical performance:

System width:	50 mm
Profile depth:	50 mm to 260 mm
Thermal insulation:	$U_f$ value up to 1.2 W/(m <sup>2</sup> K)
Infill thickness:	3 mm to 63 mm
Glass weight:	up to 5.6 kN
Polygon façade:	up to 45° (per side = 90° angle)
Roof pitch:	up to 10°

### System technology:

- Ideal for vertical and polygon façades, sloped glazing and spatial structures
- Individual design thanks to a wide range of profile geometries for the structural and glazing profiles
- Alternative: Industrial design for technical look of steel profiles
- Reliable glass load transmission (up to 5.6 kN), with adapted transom-joint technology
- Overlapping and secure drainage at the cross point, without mechanical mullion processing, ensures tried-and-tested impermeability
- Filigree look without any change in appearance to the inner mullion and transom gaskets
- Broad selection of profiles enables economic adaptation to structural requirements, with the additional option of internal reinforcement
- Glazing from outside with visible or concealed screws
- Extensive solutions for structure junctions and conservatories

### Additional options in identical design and technical set-up:

- Passive house curtain wall
- SG-design (integrated pressure profile)
- Structural glazing curtain wall
- Add-on curtain wall for steel and wood
- Integrated sun protection
- Fire protection curtain wall

# WICTEC 60

## Stick system curtain wall

Featuring a 60-mm face width (inside and outside), WICTEC 60 is a stick system façade that meets the highest demands. With minor additions, WICTEC 60 fulfils the most demanding requirements with regard to burglar and bullet resistance and fire protection.

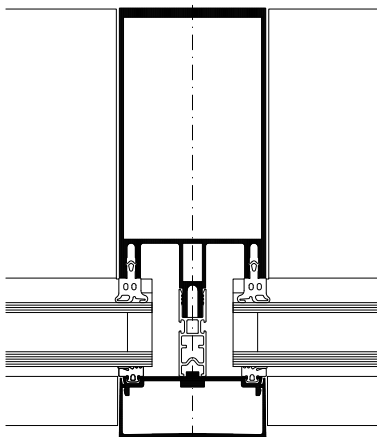

### Technical performance:

System width:	60 mm
Profile depth:	70 mm to 170 mm
Thermal insulation:	$U_f$ value up to 1.2 W/(m <sup>2</sup> K)
Infill thickness:	3 mm to 51 mm
Glass weight:	up to 5.6 kN
Roof pitch:	up to 10°

### System technology:

- Ideal for vertical façades and sloped-glazing and spatial-structure transitions
- Individual design thanks to a wide range of profile geometries for the structural and glazing profiles
- Reliable glass load transfer (up to 5.6 kN), with adapted transom-joint technology
- Overlapping and secure drainage at the cross point, without mechanical mullion processing, ensures tried-and-tested impermeability
- Filigree look without any change in appearance to the inner mullion and transom gaskets
- High static value of profiles, with the additional option of interior reinforcement
- Glazing from outside with concealed or visible screws
- Extensive solutions for structure junctions and conservatories

### System test results / CE product pass in accordance with DIN EN 13830

Air permeability:	Class AE
Watertightness:	RE 1200
Resistance to wind load:	2000 / -3200 Pa, security 3000 / -4800 Pa
Sound insulation:	$R_w(C;C_{tr}) = 47 (-1; -4)$ dB
Impact resistance:	Class E5 / I5
Burglar resistance:	RC1N, RC2N, RC2, RC3
Bullet resistance:	FB4
Quality assurance:	Certified according to ISO 9001:2008

# WICTEC 50HI

## Passive house curtain wall

### Certified passive house component



A passive house does not require an active heating system and therefore relies heavily on the thermal insulation and air-tightness of the façade. Based on the standard series, WICTEC 50 is certified for aluminium/glass façades suitable for passive houses at minimal additional cost. The thermal insulation is improved to passive-house quality with a  $U_f$  value of  $0.74 \text{ W}/(\text{m}^2\text{K})$  when using triple glazing and an easy-to-install thermal break profile.

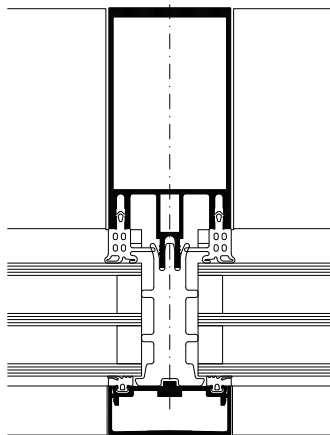

#### System test results / CE product pass in accordance with DIN EN 13830

Air permeability:	Class AE
Watertightness:	RE 1200
Resistance to wind load:	2000 / -3200 Pa, security 3000 / -4800 Pa
Sound insulation:	$R_w (C; C_{tr}) = 47 (-1; -4) \text{ dB}$
Impact resistance:	Class E5 / I5
Burglar resistance:	RC1
Quality assurance:	Certified according to ISO 9001:2008

#### Technical performance:

System width:	50 mm
Basic system:	WICTEC 50
Thermal insulation:	$U_f = 0.74 \text{ W}/(\text{m}^2\text{K})$
Infill thickness:	45 mm to 51 mm
Glass weight:	up to 5.6 kN
Polygon façade:	up to $5^\circ$

#### System technology:

- Extension to WICTEC 50 with optimised thermal insulation
- Certified by the ift Rosenheim as a passive house component according to the ift guidance paper RI WA 15/1, with a  $U_{cw}$  value of  $0.7 \text{ W}/(\text{m}^2\text{K})$
- Triplex glass construction suitable for passive houses, infill thickness from 45 mm to 51 mm
- Thermal break profile made of elastomer foam for posterior installation
- System construction identical to standard WICTEC 50
- Individual design thanks to a wide range of profile geometries for the structural and glazing profiles
- Reliable glass load transmission (up to 5.6 kN), with adapted transom-joint technology
- Overlapping and secure drainage at the cross point, without mechanical mullion processing, ensures tried-and-tested impermeability
- Filigree look without any change in appearance to the inner mullion and transom gaskets
- Broad selection of profiles enables economic adaptation to structural requirements, with the additional option of internal reinforcement



# WICTEC 50

## SG design with integrated pressure profile

Reduced profile elevations leading to maximum transparency: With its integrated pressure profile WICTEC 50 offers an inexpensive solution with a design similar to structural glazing. The glazing technology with a flush or low pressure profile the assembly is as fast and easy as for a classic stick system curtain wall.

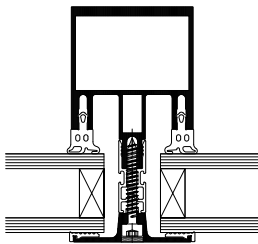

### System test results / CE product pass in accordance with DIN EN 13830

Air permeability:	Class AE
Watertightness:	RE 1200
Resistance to wind load:	2000 / -3200 Pa, security 3000 / -4800 Pa
Impact resistance:	Class E5 / I5
Burglar resistance:	RC1N
Quality assurance:	Certified according to ISO 9001:2008



#### Technical performance:

System width:	50 mm
External profile width:	43 mm / 51 mm
Thermal insulation:	22 mm to 38 mm 26 mm to 42 mm for stepped glass edge
Basic system:	WICTEC 50

#### System technology:

- Minimised visibility due to profile dimensions of only 43 mm or 51 mm pressure profile width
- Two options: with only 4 mm overlap over the glass or completely flush with processed glass edge
- Simplified standard construction with design similar to structural glazing SG curtain walling
- Replaces the silicone joint of a classic SG system, thus no maintenance of bonding and sealing, no technical approval and no supervision of production necessary
- Production and assembly like for the standard WICTEC 50 curtain wall
- Overlapping and secure drainage at the cross point, without mechanical mullion processing, ensures tried-and-tested impermeability
- Filigree look without any change in appearance to the inner mullion and transom gaskets
- Broad selection of profiles enables economic adaptation to structural requirements, with the additional option of internal reinforcement

# WICTEC 50SG Structural glazing curtain wall



A characteristic feature of WICTEC 50SG structural glazing curtain wall is the flush design with slim silicone joints between the glass panes. The system offers all-glass technology both for vertical curtain walls and sloped roof glazing. Based on the standard WICTEC 50 stick system these options can be realised with simplified and economic processing and assembly, while assuring a high quality level.

The WICLINE 90SG all-glass integrated opening sash pursues the homogeneous full glass design with Italian style or parallel outward opening function.

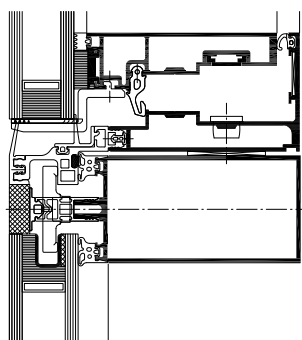

WICTEC 50SG with  
integration sash WICLINE 90SG

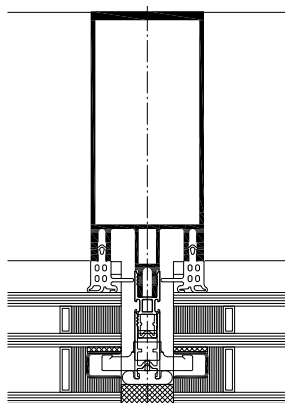

WICTEC 50SG

**System test results / CE product pass  
in accordance with DIN EN 13830**

Air permeability:	Class AE
Watertightness:	RE 750
Resistance to wind load:	2000 Pa, security ± 3000 Pa
Impact resistance:	Class E5 / I5
Approval:	ETA: -11/0042 (European Technical Approval)
Quality assurance:	Certified according to ISO 9001:2008

**Technical performance:**

System width: Internal aluminium profiles 50 mm  
External silicone joint 23 mm  
Thermal insulation:  $U_i$  up to 1.2 W/(m<sup>2</sup>K)  
Infill thickness: up to 64 mm

**System technology:**

- ETA (European Technical Approval) granted
- Outstanding appearance
- Basic structure is the WICTEC 50 curtain wall, with identical profile and gasket technology
- Easy assembly of the glazing on site, without supplementary tools
- Simple and straightforward installation thanks to a special patented fastener
- Execution also possible in combination with cover profiles in various contours
- The ideal complement: integration sash WICLINE 90SG in all-glass technology with Italian style or parallel outward opening function





# WICTEC 50A

## Add-on curtain wall for steel and wood

In certain cases, it is aesthetically or structurally beneficial to design curtain walls with supporting structures made from wood or steel. WICTEC 50A is a mounting option which makes it possible to fix the glazing on such supporting structures directly. WICTEC offers a free choice of supporting material – aluminium, steel or wood – for an identical outer appearance and glazing technology for the curtain wall.

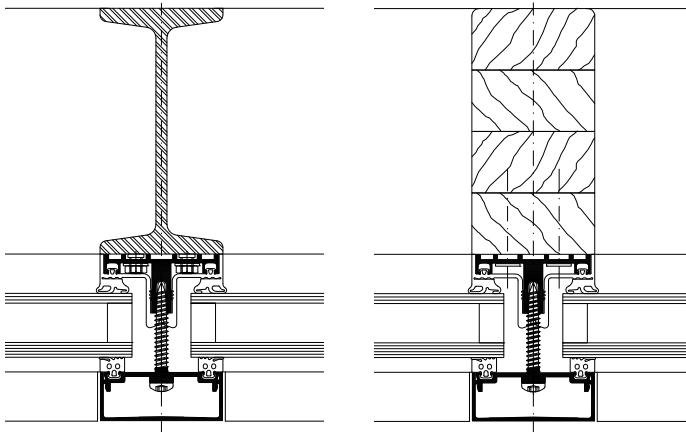

### System test results / CE product pass in accordance with DIN EN 13830

Air permeability:	Class AE
Watertightness:	RE 1200
Resistance to wind load:	2000 / -3200 Pa, security 3000 / -4800 Pa
Impact resistance:	Class E5 / I5
Burglar resistance:	RC1N, RC2N, RC2
Bullet resistance:	FB4
Quality assurance:	Certified according to ISO 9001:2008



### Technical performance:

System width: 50 mm  
 Supporting frames: from 50 mm width  
 Structural profiles: Wood profiles  
 Steel tubes  
 Open steel profiles

### System technology:

- Free choice of material (steel or wood), for profile widths from 50 mm
- Same interface profile for mullions and transoms
- Overlapping via vertical and horizontal single-piece overarching sealing profiles with different drainage levels
- Simple and efficient fixing of the aluminium profile by means of screws
- Alternative simple fixing technique using steel studs for steel tubes with a wall thickness from 4 mm
- Ideal for vertical and polygon façades, sloped glazing and spatial structures
- Glazing from outside with visible or concealed screws

# WICTEC 50EL

## Unitised curtain wall

WICTEC 50EL is a unitised version of the WICTEC 50 stick system. This range combines the advantages of the stick system structure with the assembly benefits of unitised curtain walling, with an extremely narrow sight line of only 50 or 65 mm. The exterior profiles with mitre joints on the outside achieve a particularly elegant appearance with a "picture frame effect". Particularly where there are stringent requirements pertaining to thermal insulation, WICTEC 50 EL offers the appropriate solution.

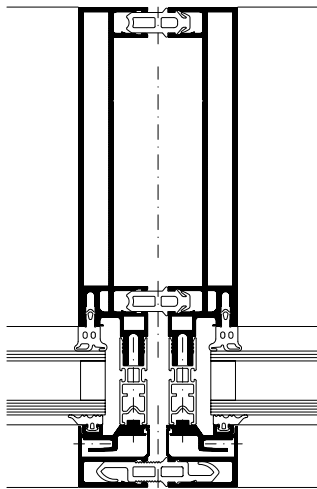

### System test results / CE product pass in accordance with DIN EN 13830

Air permeability:	Class AE
Watertightness:	RE 1200
Resistance to wind load:	2000 / -3200 Pa, security 3000 / -4800 Pa
Impact resistance:	Class E5 / I5
Quality assurance:	Certified according to ISO 9001:2008



### Technical performance:

System width:	50 mm for undivided frames 65 mm for divided frames
Profile depth:	195 mm to 213 mm, depending on the infill 130 mm inner profile elevation
Thermal insulation:	$U_i$ up to 1.4 W/(m <sup>2</sup> K) at horizontal bar $U_i$ up to 1.5 W/(m <sup>2</sup> K) at vertical bar
Infill thickness:	up to 44 mm
Unit sizes:	(w x h) up to 3000 mm x 3500 mm, up to 1500 mm width without mid posts

### System technology:

- WICTEC 50EL is a basic unitised system and can be adapted individually to meet specific project requirements
- Production of the complete units in the workshops, avoiding any weather influence and thus assuring a constantly high product quality
- Fast, efficient and projectable assembly on site
- Aluminium profiles using mullion-transom technology, with insulating profile that provides a high level of thermal insulation
- Narrow sight lines for maximum transparency
- Mullions and transoms have the same profile depth
- Efficient thermal protection up to  $U_i = 1.4$  W/(m<sup>2</sup>K)
- Reliable corner connection with system brackets
- Easy installation on the construction site, with special system anchors



# WICTEC EL60

## Unitised curtain wall



WICTEC EL60 is the slim version within the unitised curtain wall systems, with especially reduced sight lines of just 60 mm both inside and outside. The exterior glazing profiles with mitre joints achieve a particularly elegant appearance with a “picture frame effect”. As a result of optimised thermal insulation, the system leads the way with outstanding  $U_{cw}$  values of up to  $0.9 \text{ W}/(\text{m}^2\text{K})$ .

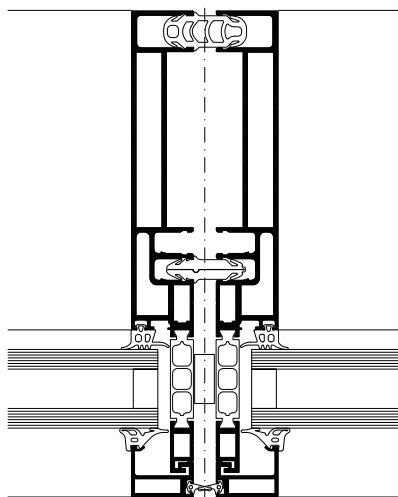

### System test results / CE product pass in accordance with DIN EN 13830

Air permeability:	Class AE
Watertightness:	RE 1200
Resistance to wind load:	2000 / -3200 Pa, security 3000 / -4800 Pa
Impact resistance:	Class E5 / I5
Quality assurance:	Certified according to ISO 9001:2008

### Technical performance:

System width:	60 mm
Profile depth:	198 mm
Thermal insulation:	$U_f$ for support and bar profiles up to $1.6 \text{ W}/(\text{m}^2\text{K})$ $U_f$ for frame combinations up to $1.8 \text{ W}/(\text{m}^2\text{K})$ $U_{cw}$ up to $0.9 \text{ W}/(\text{m}^2\text{K})$
Infill thickness:	Up to 36 mm as standard system, above on request
Unit sizes:	(w x h) up to 2800 mm x 3500 mm, up to 1500 mm width without mid posts

### System technology:

- WICTEC EL60 is a basic unitised system and can be adapted individually to meet specific project requirement
- Production of the complete units in the workshops, avoiding any weather influence and thus assuring a constantly high product quality
- Fast, efficient and projectable assembly on site
- Aluminium composite profiles with excellent thermal insulation, from quality-assured and monitored production
- Slim sight lines of only 60 mm, with divided and undivided profiles
- Mullions and transoms have the same profile depth
- Reliable corner connection with corner brackets
- On the construction site, the units are easily installed in the façade anchors from the system range



# WICTEC 50FP / WICTEC 60FP Fire protection curtain wall

WICTEC 50FP and WICTEC 60FP for fire protection façades in the G30 and F30 classes: no matter whether stairwells, extensions, hallways or glazed roofs – with WICTEC FP all types of façade and architectural concepts can be adapted to the necessary protection requirements.

The FP design is based on the WICTEC 50 and 60 standard façades, meaning that fire protection solutions can be integrated into standard solutions in a homogeneous and functional manner.

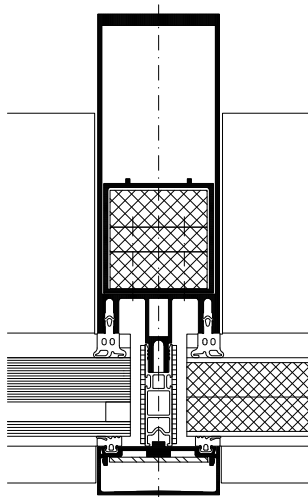

### System test results / CE product pass in accordance with DIN EN 13830

Air permeability:	Class AE
Watertightness:	RE 1200
Resistance to wind load:	2000 / -3200, safety 3000 / -4800 Pa
Impact resistance:	Class E5 / I5
German approval:	For vertical curtain wall and overhead glazing in F30 and G30
Quality assurance:	Certified according to ISO 9001:2008



### Technical performance:

System width:	50 mm / 60 mm
Basic system:	WICTEC 50 / WICTEC 60
Fire protection classes:	G30 / F30
Infill dimensions:	Portrait format up to 1800 mm x 3000 mm Landscape format up to 2400 mm x 1400 mm
Height of façade:	up to 5000 mm
Polygon façade:	up to ± 5°
Infill thickness:	F30: 15 mm to 38 mm G30: 7 mm to 38 mm

### System technology:

- For vertical and overhead glazing (fire protection up to 0° inclination)
- Slim sight lines: 50 mm or 60 mm
- Compatible and structurally identical with WICTEC 50 and WICTEC 60 standard systems
- Infills: glass or panel
- Extended freedom in design with big possible infill dimensions
- Suitable for interior and exterior application
- The WICONA fire protection parapet, in resistance class W90, offers the appropriate solution to prevent fire flashover with standard façades.
- Can also be combined with WICSTYLE 77FP fire protection doors and WICLINE 75FP fire protection windows



# WICTEC

## Curtain wall systems

### Burglar resistance

Personal security and building protection – for your building you need a solution approach which can be accomplished with aluminium systems in a holistic and compatible way. This is achieved by the WICONA series for curtain walls, windows and doors. Each of them can be executed in burglar resistance, in combination with other additional functions. The various levels of resistance classes can be achieved with WICTEC stick curtain wall series without visual alterations of the constructions, with only a minimum of additional measures on the basis of the standard design.

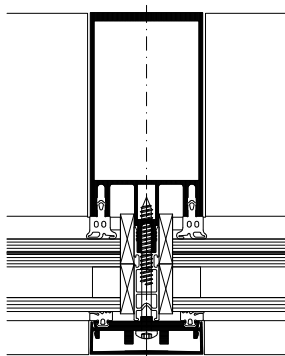

WICTEC 50 RC2

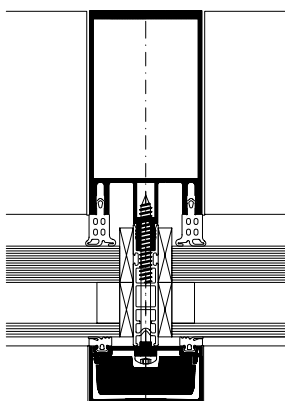

WICTEC 50 RC3

**System test results/CE product pass in accordance with DIN EN 13830**

See classification of the respective WICTEC curtain wall series.



#### Technical performance:

##### Burglar resistance according to DIN EN 1627:

- The currently valid standard for burglar resistance, DIN EN 1627, has come into effect in European countries in 2011 and 2012. It replaced former national standards, like in Germany since September 2011 the standard DIN 1627. The classifications have been modified to classes RC1N to RC3, which are not identical with the former classes WK1 to WK3, as the test sequences have been changed.

##### Test results of the WICONA window series:

- The test results of the WICTEC curtain wall series have been assigned according to the new standard EN 1627. They can easily be specified and implemented without any additional measurement according to this new standard.

##### Burglar resistance according to DIN EN 1627 resp. DIN 1627 / classifications:

WICTEC 50	RC1N, RC2N, RC2, RC3
WICTEC 60	RC1N, RC2N, RC2, RC3
WICTEC 50 Passive house curtain wall	RC1N
WICTEC 50 Integrated pressure profile	RC1N
WICTEC 50A Add-on curtain wall	RC1N, RC2N, RC2

# WICTEC

## curtain wall systems

### Bullet resistance

Personal security and building protection – for your building you need a solution approach which can be accomplished with aluminium systems in a wholistic and compatible way. This is achieved by the WICONA series for curtain walls, windows and doors. Each of them can be executed in bullet resistance, in combination with other additional functions. The requirements for bullet resistance are achieved with WICTEC curtain wall series, simply by addition of the standard construction with a special aluminium planking.

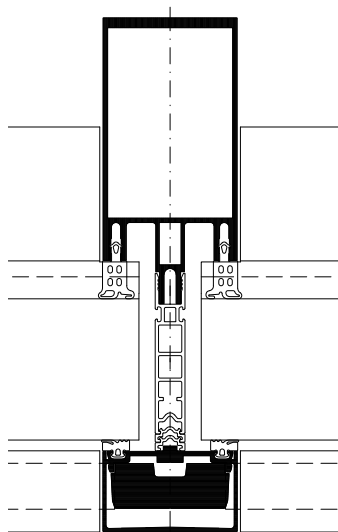

**System test results / CE product pass in accordance with DIN EN 13830**

See classification of the respective WICTEC curtain wall series.

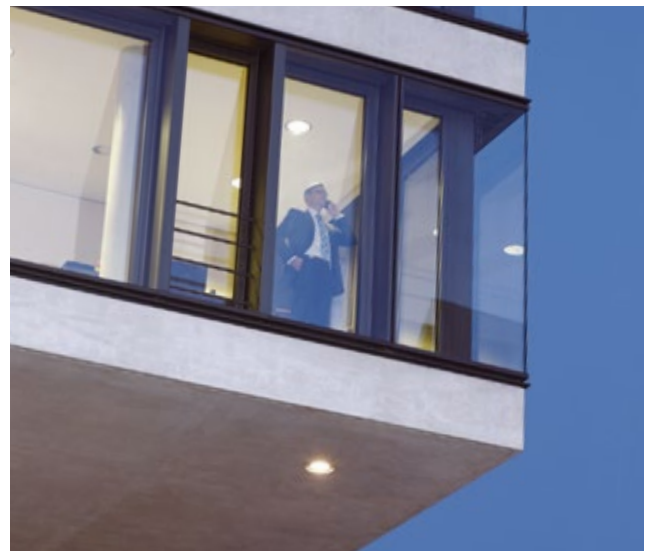

#### Technical performance:

##### Bullet resistance according to DIN EN 1522

- The bullet resistance requirements for curtain walls are regulated Europe wide in the standard DIN EN 1522. The WICTEC curtain wall series have been tested according to this standard in various profile combinations, and successfully been certified in class FB4.
- Bullet resistance can be combined with burglar resistance in the classes RC1N, RC2N, RC2, RC3 according to DIN EN 1627.

##### Possible combinations with other WICONA product series in bullet resistance in class FB4:

- Doors WICSTYLE 65 evo / WICSTYLE 75 evo
- Windows WICLINE 65 evo / WICLINE 75 evo

##### Bullet resistance according to DIN EN 1522 / classifications:

WICTEC 50	FB4
WICTEC 60	FB4
WICTEC 50A Add-on construction	FB4

WICLINE 65 evo /  
WICLINE 75 evo  
Integration sash  
Turn / tilt-turn / turn sash

The ideal combination: WICTEC stick system curtain walls with integrated opening sashes from the WICLINE window series. The versatile systems with extended performances offer individual solutions on highest technical and design level, adaptable with a large selection of additional functions.

2 |

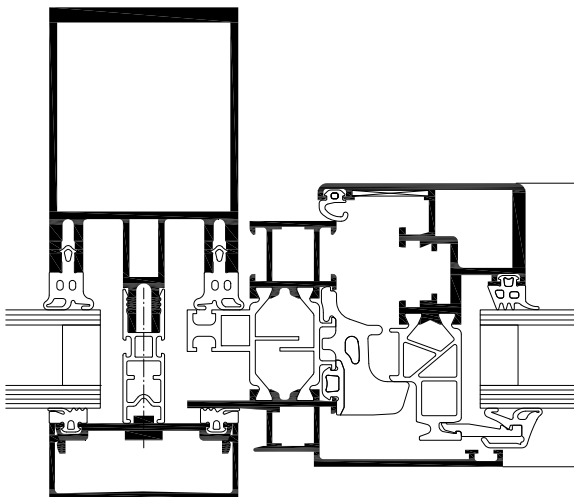

**System test results / CE product pass in accordance with DIN EN 14351-1:2006+A1:2010 and DIN EN 13830**

See classification of the WICLINE window series and the WICTEC curtain wall series.

1 | Example standard sash  
2 | Example concealed sash

1 |



**Technical performance:**

**Profile technology:**

- High insulation multi-chamber system in symmetric design, quality assured thermal insulator connection
- Patented corner and butt joint connection technology for high rigidity of frames and sashes

**Thermal insulation:**

- $U_f$  values until 1.2 W/(m<sup>2</sup>K)
- $U_{CW}$  values depending on the combination of curtain wall and sash

**Inward opening options:**

- Turn / turn-tilt / tilt window
- Concealed sash
- Burglar resistance

**Fittings:**

- Heavy duty system fittings with:
  - visible hinges, powder coating or anodization in all colours
  - concealed hinges with integrated end position damping, opening angle max. 105°
- Sash weight:
  - Visible turn / tilt fittings: up to 160 kg
  - Concealed turn / tilt fittings: up to 200 kg
  - Turn hinges (on demand): up to 300 kg
- Sash sizes (w x h): 1700 mm x 2500 mm
- Optionally with opening limiter in various executions

WICLINE 65 evo /  
WICLINE 75 evo Integration sash,  
outward opening, Top-hung  
sash / side-hung sash

A sash opening towards the outside offers many substantial advantages like effective ventilation, the choice between manual and motorised operation, and avoids a disturbing sash towards the inside. With very big possible sash dimensions and optimised functionality WICLINE evo offers an interesting alternative opening type for architecture.

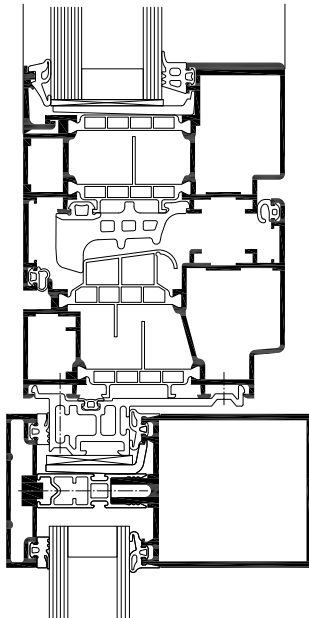

**System test results / CE product pass in accordance with DIN EN 14351-1:2006+A1:2010**

Air permeability:	Class 4
Watertightness:	E1200
Resistance to wind load:	Class C5 / B5
Operating forces:	Class 1
Load bearing capacity of safety devices:	Fulfilled
Mechanical strength:	Class 4
Repeated opening / closing:	Class 2 (10,000 cycles)
Impact resistance:	Class 3
Quality assurance:	Certified according to ISO 9001:2008



**Technical performance:**

**Profile technology:**

- High insulation multi-chamber system in symmetric design, quality assured thermal insulator connection
- Patented corner and butt joint connection technology for high rigidity of frames and sashes
- Infill thickness up to 69 mm
- Optionally with frame for punched hole application

**Thermal insulation:**

- $U_f$  values until 1.5 W/(m<sup>2</sup>K)
- $U_w$  values until 0.94 W/(m<sup>2</sup>K)

**Sealing concept:**

- Special multi-chamber centre gasket with fins for superior tightness and improved thermal insulation

**Fittings:**

- Externally applied turn hinges, optionally with
  - top fixation for top-hung opening
  - lateral fixation for side-hung opening
- Operation either manual or motorised
- Sash weight until 150 kg
- Sash sizes (w x h): until 2000 mm x 2000 mm





# WICLINE 65 evo / WICLINE 75 evo

## Integration sash, outward opening, Italian sash

An elegant appearance combined with efficient ventilation are the characteristics of the aluminium system WICLINE evo in its Italian opening version. Concealed friction stays ensure an outward opening also for large size sashes, with a secure opening fixation in any position. Special frame profiles for curtain wall integration as well as a large selection of friction stay sizes guarantee maximum versatility of the system.

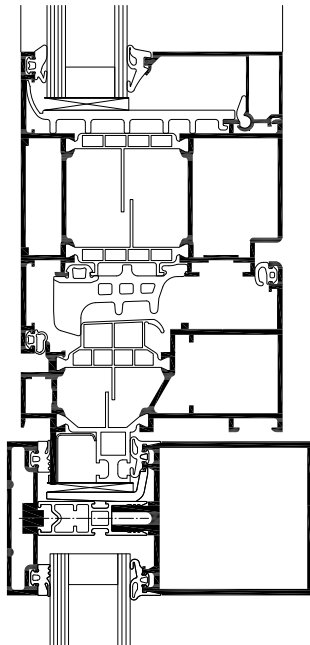

### System test results / CE product pass in accordance with DIN EN 14351-1:2006+A1:2010

Air permeability:	Class 4
Watertightness:	E1200
Resistance to wind load:	Class C5 / B5
Operating forces:	Class 1
Mechanical strength:	Class 4
Repeated opening / closing:	Class 2 (10,000 cycles)
Impact resistance:	Class 3
Quality assurance:	Certified according to ISO 9001:2008



### Technical performance:

#### Profile technology:

- High insulation multi-chamber system in symmetric design, quality assured thermal insulator connection
- Patented corner and butt joint connection technology for high rigidity of frames and sashes
- Infill thickness up to 69 mm
- Optionally with frame for punched hole application

#### Thermal insulation:

- $U_f$  values: until 1.5 W/(m<sup>2</sup>K)
- $U_w$  values: until 1.0 W/(m<sup>2</sup>K) with triple glazing

#### Sealing concept:

- Voluminous centre gasket with formed corners

#### Fittings:

- Concealed integrated friction stay fittings, with vertical adjustment
- Operation either manual or motorised
- Sash weight: until 150 kg
- Sash formats (w x h): until 2000 mm x 2200 mm

# WICLINE 65 evo / WICLINE 75 evo

## Integration pivot sash, horizontal or vertical

A classic opening type becomes again a state-of-the-art product with WICONA technology: The horizontal and the vertical pivot windows based on the aluminium window system WICLINE evo offer improved thermal insulation, have achieved high classifications in CE-testing each, and with their option of visible or concealed fittings they are a real visual highlight for any façade integration.

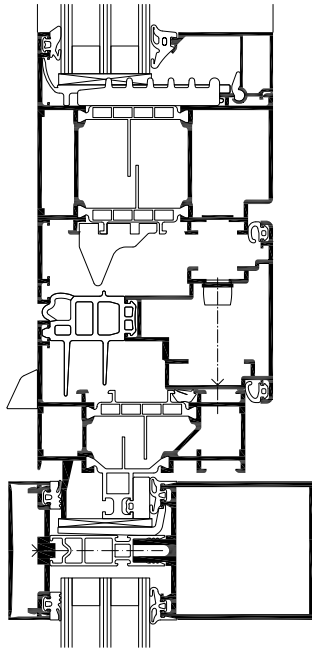

### System test results / CE product pass in accordance with DIN EN 14351-1:2006+A1:2010

	Horizontal	Vertical
Air permeability:	Class 4	Class 4
Watertightness:	E750	4A
Resistance to wind load:	Class C5 / B5	Class C5 / B5
Operating forces:	Class 1	Class 1
Mechanical strength:	Class 4	Class 4
Repeated opening / closing:	Class 2 (10,000 cycles)	Class 2 (10,000 cycles)
Quality assurance:	Certified according to ISO 9001:2008	



### Technical performance:

#### Profile technology:

- High insulation multi-chamber system in symmetric design, quality assured thermal insulator connection
- Patented corner and butt joint connection technology for high rigidity of frames and sashes
- Infill thickness up to 69 mm
- Optionally with frame for punched hole application

#### Thermal insulation:

- $U_f$  values: until 1.5 W/(m<sup>2</sup>K)
- $U_w$  values: until 1.0 W/(m<sup>2</sup>K) with triple glazing

#### Sealing concept:

- Special multi-chamber centre gasket with fins for superior tightness and improved thermal insulation

#### Fittings:

- Horizontal or vertical pivot fittings, optionally with
  - visible bearings or
  - concealed bearings
- Sash weight:
  - Horizontal: up to 150 kg
  - Vertical: up to 120 kg
- Sash formats (w x h):
  - Horizontal: up to 2400 mm x 1400 mm
  - Vertical: up to 2000 mm x 2000 mm



# WICLINE 90SG

## Structural glazing integration sash, Italian sash / parallel outward opening sash



As an attractive complement for curtain walls the integration sash WICLINE 90SG provides efficient ventilation, if requested also fully automated.

This all-glass sash gives full options as a projecting top-hung sash or as a parallel outward opening sash and can be integrated flush with the glass pane level in WICTEC 50SG structural glazing curtain walling or in stick systems with exterior pressure profiles.

For an optimum thermal insulation WICLINE 90SG can be equipped with double or triple glazing. Using standard glass without glass step leads to an economy of cost and improved safety.

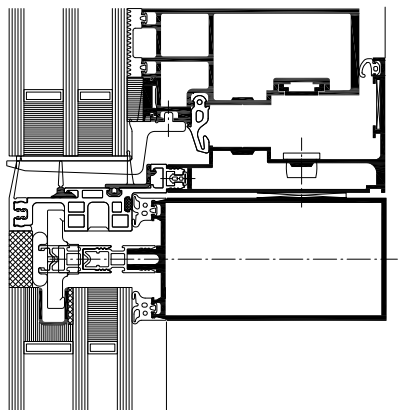

### System test results / CE product pass in accordance with DIN EN 14351-1:2006+A1:2010

Air permeability:	Class 4
Watertightness:	E750
Resistance to wind load:	Class C4 / B4
Repeated opening / closing:	Class 2 (10,000 cycles)
Impact resistance:	Class 3
Load bearing capacity of safety devices:	Fulfilled
Approval	ETA: -11/0042 (European Technical Approval)
Quality assurance:	Certified according to ISO 9001:2008

### Technical performance:

#### Profile technology:

- All-glass sash with slim profile design for maximum transparency and finelined window structures. Construction depth 189 mm, interior width 55 mm
- ETA granted (European Technical Approval)
- Infill thickness up to 62 mm
- For double or triplex glass
- Technology without step glazing, leading to economy and simpler assembly
- Complete fittings from WICONA for manual or motor operation

#### Thermal insulation:

- $U_i$  value until 1.1 W/(m<sup>2</sup>K)

#### Italian sash application:

- Sash weight until 180 kg
- Sash formats (w x h): until 1500 mm x 2500 mm or until 2000 mm x 1700 mm

#### Parallel outward sash application:

- Sash weight until 200 kg
- Sash formats (w x h): until 1500 mm x 3000 mm or until 2000 mm x 1500 mm



# WICTEC 50

## Integration sash

### Skylight window

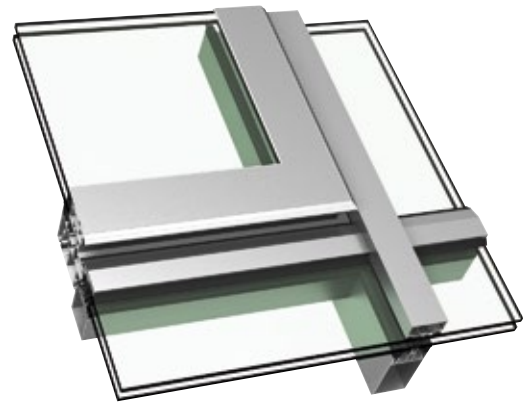

The quality requirements for ventilation sashes are particularly high for those installed in the roof. WICTEC 50 meets these requirements and delivers a delicate appearance with minimal offset of the glass level. Minimised profile widths, concealed hinges with 90° opening angle and the option of large sash formats offer extensive freedom of design. Thanks to the large ventilation cross sections, the WICTEC 50 skylight is also ideal for use as natural smoke and heat exhaust ventilators.

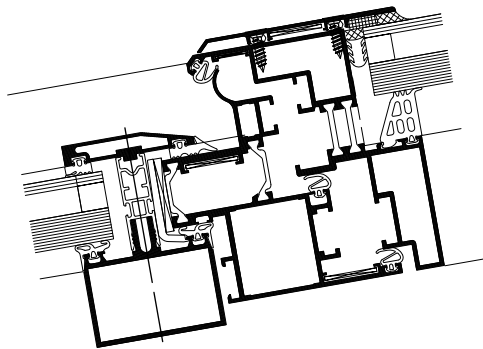

**System test results / CE product pass in accordance with DIN EN 14351-1:2006+A1:2010**

Air permeability:	Class 4
Watertightness:	9A
Resistance to wind load:	Class C5 / B5
Quality assurance:	Certified according to ISO 9001:2008

**Technical performance:**

**Profile technology:**

- High insulation triple-chamber system, quality assured thermal insulator connection
- Slim design with only 81 mm visible sight line
  - Offset against the glass only 36 mm
  - Application in sloped glazing until 10°

**Fittings:**

- Concealed turn hinges
  - Opening angle 90°
  - Manual or motorised operation

**Sash weight:**

- Until 130 kg
- Sash formats (w x h): until 1800 mm x 1400 mm or until 1400 mm x 1800 mm

**Additional options:**

- NSHEV: tested and approved as natural smoke and heat extraction ventilation unit.



# WICLINE 75 evo ventilation flap Project solution

With a thermally insulated aluminium turn sash for integration into stick façades or window constructions, the WICLINE evo ventilation flap meets the frequent requirement for a manually or motor operated ventilation, adapted for perfect visual integration into the curtain wall.

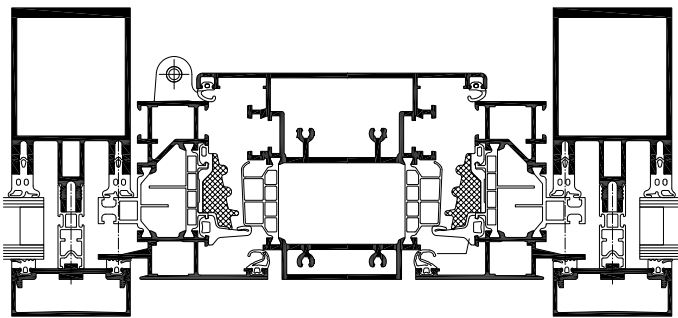

WICLINE 75 evo ventilation flap 250

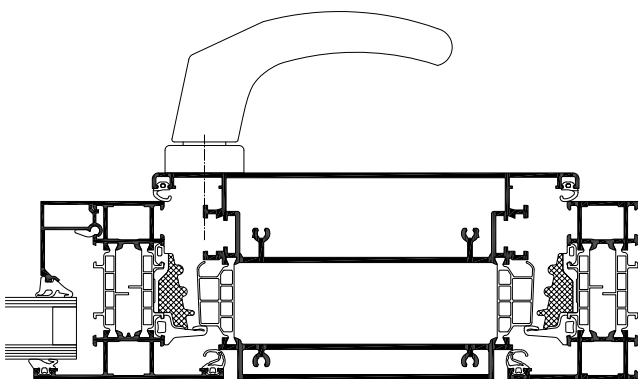

WICLINE 75 evo ventilation flap 180



## Technical performance:

### System technology:

- High insulation turn sash with 180 mm or 250 mm visible width
- System depth 75 mm, sash depth 87 mm
- Profiles prepared for full motor integration
- Slim, homogeneous design
- Profile processing by 90° cutting saw or notch cuts
- Centre gasket on all four sides with formed corners

### Thermal insulation:

- $U_f$  value stepwise adaptable until 1.2 W/(m<sup>2</sup>K)

### Fittings:

- Manual operation:
  - Visible hinges and fittings, powder coated or anodised, for sash width 250 mm
  - Concealed hinges with integrated end position damping for sash width 180 mm and 250 mm
- Fully integrated motor drive (on demand):
  - With visible turn hinges
  - No motor chains
  - Adjustable opening angle
  - Control by switch, remote or central control
- Sash weight: 80 kg
- Sash sizes (w x h): 180 mm x 3000 mm or 250 mm x 3000 mm
- Optionally opening limiter for visible hinges, integrated for concealed fittings



# WICLINE 65 evo

Turn, turn-tilt, tilt, tilt-first,  
double casement  
windows / fanlights



State of the art technology and a comprehensive profile range make the aluminium window WICLINE 65 evo a perfect all-rounder with a versatile spectrum of applications.

By using a design depth of only 65 mm, this system meets high standards required for thermal and sound insulation. WICLINE 65 evo offers a very attractive price/performance ratio.

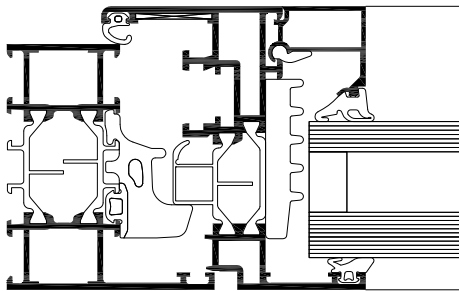

**System test results / CE product pass in accordance with DIN EN 14351-1:2006+A1:2010**

Air permeability:	Class 4
Watertightness:	E900
Resistance to wind load:	Class C5/B5
Acoustic performance:	$R_w(C;C_{tr}) = 47 (-1; -4)$ dB
Operating forces:	Class 1
Load bearing capacity of safety devices:	Fulfilled
Mechanical strength:	Class 4
Repeated opening / closing:	Class 3 (20,000 cycles)
Corrosion resistance of the fittings:	Class 5
Burglar resistance:	RC1N, RC2N, RC2, RC3
Bullet resistance:	FB4 S, FB4 NS (depending on the profile combination)
Quality assurance:	Certified according to ISO 9001:2008

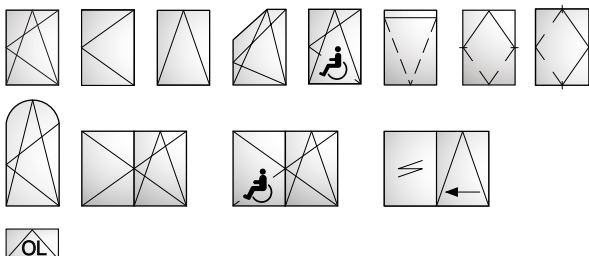

**Technical performance:**

**Profile technology:**

- High insulation multi-chamber system in symmetric design, quality assured thermal insulator connection
- Patented corner and butt joint connection technology for high rigidity of frames and sashes
- Infill thickness up to 59 mm

**Thermal insulation:**

- $U_f$  values: until 1.4 W/(m<sup>2</sup>K)
- $U_w$  values: until 0.93 W/(m<sup>2</sup>K) with triple glazing

**Sealing concept:**

- Voluminous centre gasket with three installation methods
  - Circumferential centre gasket, no joints in the corner areas
  - Formed corners, avoiding adhesive in the joints
  - Corner vulcanised frames

**Fittings:**

- Heavy duty system fittings with:
  - visible hinges, powder coating or anodization in all colours
  - concealed hinges with integrated end position damping, opening angle max. 105°
- Sash weight:
  - Visible fittings: up to 160 kg
  - Concealed fittings: up to 200 kg
  - On demand: up to 300 kg
- Sash sizes (w x h): 1700 mm x 2500 mm, fanlight 2500 mm x 1700 mm
- Optionally with opening limiter in various executions

**Additional designs:**

- Concealed sash
- Classic design
- Integration frame for stick façades
- Fanlight with hand lever, cranked rod or motor
- Pivot window, horizontal or vertical
- Parallel sliding window, with or without force operation
- Italian style window
- Top-hung window
- Window doors with barrier free threshold, single or double casement door, inward and outward opening
- Burglar resistance (see system tests)
- Bullet resistance (see system tests)

**Compatible with the door series WICSTYLE 65 evo and WICSTYLE 75 evo**

# WICLINE 75 evo

Turn, turn-tilt, tilt, tilt-first,  
double casement windows /  
fanlights / Minergie-P module



With 75 mm profile depth, WICLINE 75 evo features the highest thermal insulation properties and structural characteristics. With its superior technical performance this aluminium window is attuned to all architectural requirements of the future. In Switzerland WICLINE 75 evo has been the first metal window to be certified as Minergie-P module window.

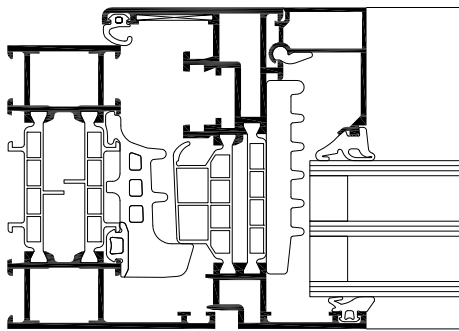

**System test results / CE product pass in accordance with DIN EN 14351-1:2006+A1:2010**

Air permeability:	Class 4
Watertightness:	E900
Resistance to wind load:	Class C5/B5
Acoustic performance:	$R_w (C; C_{tr}) = 47 (-1; -4)$ dB
Operating forces:	Class 1
Load bearing capacity of safety devices:	Fulfilled
Mechanical strength:	Class 4
Repeated opening/closing:	Class 3 (20,000 cycles)
Corrosion resistance of the fittings:	Class 5
Burglar resistance:	RC1N, RC2N, RC2, RC3
Bullet resistance:	FB4 S, FB4 NS (depending on the profile combination)
Quality assurance:	Certified according to ISO 9001:2008

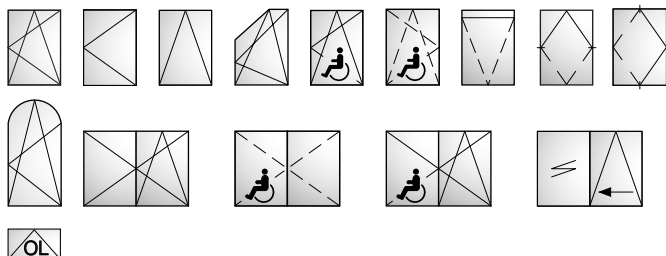

**Technical performance:**

**Profile technology:**

- High insulation multi-chamber system in symmetric design, quality assured thermal insulator connection
- Patented corner and butt joint connection technology for high rigidity of frames and sashes
- Infill thickness up to 69 mm

**Thermal insulation:**

- $U_f$  values: until 1.2 W/(m<sup>2</sup>K)
- $U_w$  values: until 0.87 W/(m<sup>2</sup>K) for sashes, until 0.72 W/(m<sup>2</sup>K) for fixed glazing, with triple glazing
- Certified as Minergie-P module  $U_w \leq 0.8$  W/(m<sup>2</sup>K)

**Sealing concept:**

- Voluminous centre gasket with three installation methods
  - Circumferential centre gasket, no joints in the corner areas
  - Formed corners, avoiding adhesive in the joints
  - Corner vulcanised frames

**Fittings:**

- Heavy duty system fittings with:
  - visible hinges and fittings, powder coating or anodisation in all colours
  - concealed hinges with integrated end position damping, opening angle max. 105°
- Sash weight:
  - Visible fittings: up to 160 kg
  - Concealed fittings: up to 200 kg
  - On demand: up to 300 kg
- Sash sizes (w x h): 1700 mm x 2500 mm, fanlight 2500 mm x 1700 mm
- Optionally with opening limiter

**Additional designs:**

- Concealed sash
- Classic design
- Integration frame for stick façades
- Fanlight with hand lever, cranked rod or motor
- Pivot window, horizontal or vertical
- Parallel sliding window, with or without force operation
- Italian style window
- Top-hung window
- Window doors with barrier free threshold, single or double casement door, inward and outward opening

**Compatible with the door series WICSTYLE 65 evo and WICSTYLE 75 evo**

# WICLINE 65 evo/ WICLINE 75 evo Concealed sash



The option "Concealed Sash" in the aluminium window system WICLINE evo features a special glazing bead fixed directly in the thermal break zone. As a result the system achieves an extremely slim frame elevation, superior thermal insulation values and a groove-free profile design from outside. The improved ratio between frame and glazing surfaces leads to very good  $U_w$ -values, increased light transmissions and panoramic views.

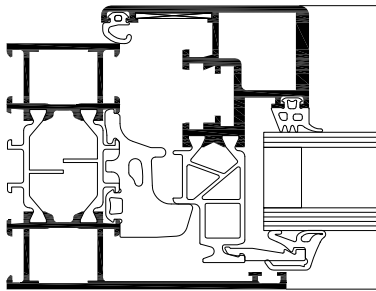

**System test results / CE product pass in accordance with DIN EN 14351-1:2006+A1:2010**

Air permeability:	Class 4
Watertightness:	E1200
Resistance to wind load:	Class C5 / B5
Operating forces:	Class 1
Load bearing capacity of safety devices:	Fulfilled
Mechanical strength:	Class 4
Repeated opening / closing:	Class 2 (10,000 cycles)
Impact resistance:	Class 3
Burglar resistance:	RC1N, RC2N, RC2, RC3
Quality assurance:	Certified according to ISO 9001:2008

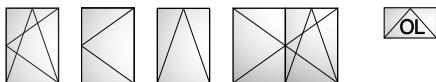

**Technical performance:**

**Profile technology:**

- High insulation multi-chamber system in symmetric design, quality assured thermal insulator connection
- Patented corner and butt joint connection technology for high rigidity of frames and sashes
- Infill thickness up to 42 mm
- Optionally with integration frame for stick curtain walls

**Thermal insulation:**

- $U_f$  values: until 1.5 W/(m<sup>2</sup>K)
- $U_w$  values: until 0.94 W/(m<sup>2</sup>K) with triple glazing

**Sealing concept:**

- Voluminous centre gasket with three installation methods
  - Circumferential centre gasket, avoiding joints in the corner areas
  - Formed corners, avoiding adhesive in the joints
  - Corner vulcanised frames

**Fittings:**

- Heavy duty system fittings, with concealed hinges, integrated end position damping, opening angle max. 105°
- Sash weight:
  - Concealed fittings: up to 130 kg
- Sash sizes (w x h): 1300 mm x 2250 mm
- Optionally with opening limiter in various executions

**Additional designs in concealed sash design:**

- Integration frame for stick façades
- Fanlight
- Burglar resistance (see system tests)



# WICLINE 65 evo/ WICLINE 75 evo Classic design



Bevelled profile contours and overlapping sashes are characteristic for the aluminium window series WICLINE evo in classic design. This design underlines a style which is often requested for residential architecture. Ideal for new building and for energetic renovations alike.

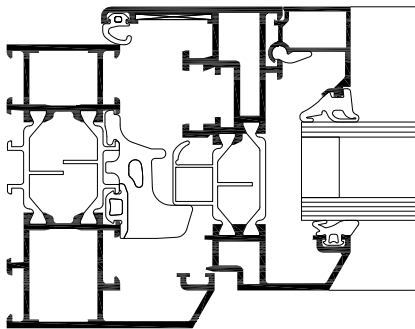

**System test results / CE product pass in accordance with DIN EN 14351-1:2006+A1:2010**

Air permeability:	Class 4
Watertightness:	E900
Resistance to wind load:	Class C5/B5
Acoustic performance:	$R_w (C; C_{tr}) = 47 (-1; -4)$ dB
Operating forces:	Class 1
Load bearing capacity of safety devices:	Fulfilled
Mechanical strength:	Class 4
Repeated opening/closing:	Class 3 (20,000 cycles)
Corrosion resistance of the fittings:	Class 5
Burglar resistance:	RC1N, RC2N, RC2, RC3
Quality assurance:	Certified according to ISO 9001:2008



**Technical performance:**

**Profile technology:**

- High insulation multi-chamber system in symmetric design, quality assured thermal insulator connection, with 30° bevelled glazing rebates
- Patented corner and butt joint connection technology for high rigidity of frames and sashes
- Infill thickness up to 59 mm

**Thermal insulation:**

- $U_f$  values: until 1.5 W/(m²K)
- $U_w$  values: until 0.84 W/(m²K) with triple glazing

**Sealing concept:**

- Voluminous centre gasket with three installation methods
  - Circumferential centre gasket, avoiding joints in the corner areas
  - Formed corners, avoiding adhesive in the joints
  - Corner vulcanised frames

**Fittings:**

- Heavy duty system fittings with:
  - visible hinges, powder coating or anodization in all colours
  - concealed hinges with integrated end position damping, opening angle max. 105°
- Sash weight:
  - Visible fittings: up to 100 kg
  - Concealed fittings: up to 100 kg
- Sash sizes (w x h): 1300 mm x 1700 mm
- Optionally with opening limiter in various executions

**Additional options in classic design:**

- Flush sash in classic design
- Overlapping sash and frame in classic design
- Fixed glazing
- Double casement window
- Crossbar profiles and glazing bars
- Integration frame for stick façades
- Fanlight
- Burglar resistance (see system tests)

# WICLINE 65 evo / WICLINE 75 evo French door, barrier free



With extended sash formats, single or double casement option and barrier free threshold this aluminium window door with inward or outward opening offers new freedom in architectural design. Superior technical performance and exemplary thermal insulation set new standards.

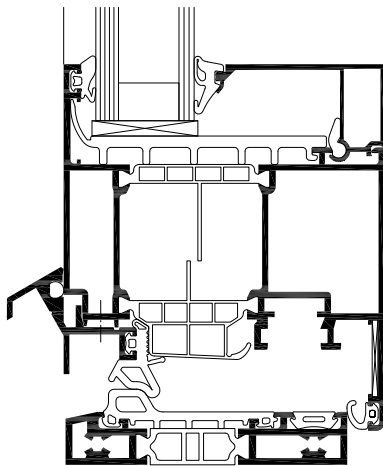

**System test results / CE product pass in accordance with DIN EN 14351-1:2006+A1:2010**

	Inward opening	Outward opening
Air permeability:	Class 4	Class 4
Watertightness:	Until E900	7A
Resistance to wind load:	Until Class C5/B5	Class C3/B3
Operating forces:	Class 1	Class 1
Mechanical strength:	Class 4	Class 4
Repeated opening/closing:	Class 2 (10,000 cycles)	Class 2 (10,000 cycles)
Quality assurance:	Certified according to ISO 9001:2008	



### Technical performance:

#### Profile technology:

- High insulation multi-chamber system in symmetric design, quality assured thermal insulator connection
- Patented corner and butt joint connection technology for high rigidity of frames and sashes
- Infill thickness up to 69 mm
- Optional: barrier free threshold, thermally insulated

#### Thermal insulation:

- $U_f$  values: until 1.3 W/(m<sup>2</sup>K)

#### Sealing concept:

- Voluminous centre gasket with three installation methods
  - Circumferential centre gasket, avoiding joints in the corner areas
  - Formed corners, avoiding adhesive in the joints
  - Corner vulcanised frames on 3 sides

#### Fittings:

- Alternatively inward or outward opening
- Single or double sash option
- Inward opening option with heavy duty system fittings, with visible hinges, powder coating or anodization in various colours.
- Sash weight:
  - Up to 130 kg
- Sash sizes (w x h):
  - Inward opening: up to 1400 mm x 2500 mm
  - Outward opening: up to 1300 mm x 2250 mm
- Optionally with opening limiter in various executions

#### Compatible with the door series

**WICSTYLE 65 evo and WICSTYLE 75 evo**

# WICLINE 65 evo/ WICLINE 75 evo Tilt slide window

In this space saving opening version the sash can be tilted or slid away to the side with ease. High operation comfort, versatile ventilation positioning without disturbing sash and the elevated technical performance values are characteristic for this opening type of the WICLINE evo aluminium window system.

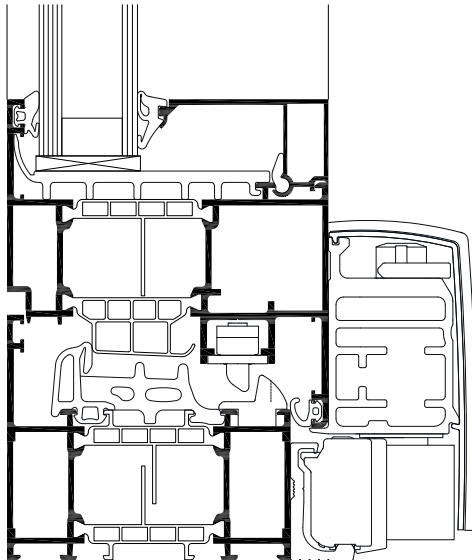

**System test results/CE product pass in accordance with DIN EN 14351-1:2006+A1:2010**

Air permeability:	Class 4
Watertightness:	E750
Resistance to wind load:	Class C5/B5
Operating forces:	Class 1
Mechanical strength:	Class 4
Repeated opening/closing:	Class 2 (10,000 cycles)
Quality assurance:	Certified according to ISO 9001:2008

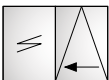

**Technical performance:**

**Profile technology:**

- High insulation multi-chamber system in symmetric design, quality assured thermal insulator connection
- Patented corner and butt joint connection technology for high rigidity of frames and sashes
- Infill thickness up to 69 mm

**Thermal insulation:**

- $U_f$  values: until 1.2 W/(m<sup>2</sup>K)

**Sealing concept:**

- Voluminous centre gasket in corner vulcanised frames

**Fittings:**

- Tilt slide fittings, optionally
  - without force operation
  - with force operation (wfo)
- Sash weight:
  - Up to 160 kg
  - Up to 200 kg (wfo)
- Sash formats (w x h):
  - Up to 1685 mm x 2500 mm
  - Up to 2000 mm x 2700 mm (wfo)

**Compatible with the door series  
WICSTYLE 65 evo and WICSTYLE 75 evo**

# WICLINE 65 evo / WICLINE 75 evo Top-hung / Side-hung window (outward)

The outward opening function frequently offers substantial benefits: efficient ventilation, no disturbing sash in the room, manual or motorised operation. With its very large sash formats and optimised functions WICLINE evo features in this option a more than interesting alternative for architecture.

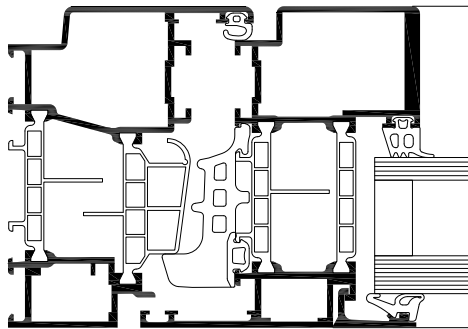

**System test results / CE product pass in accordance with DIN EN 14351-1:2006+A1:2010**

Air permeability:	Class 4
Watertightness:	E1200
Resistance to wind load:	Class C5/B5
Operating forces:	Class 1
Load bearing capacity of safety devices:	Fulfilled
Mechanical strength:	Class 4
Repeated opening/closing:	Class 2 (10,000 cycles)
Impact resistance:	Class 3
Quality assurance:	Certified according to ISO 9001:2008

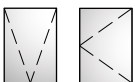

**Technical performance:**

**Profile technology:**

- High insulation multi-chamber system in symmetric design, quality assured thermal insulator connection
- Patented corner and butt joint connection technology for high rigidity of frames and sashes
- Infill thickness up to 69 mm
- Optionally with integration frame for stick system curtain walls

**Thermal insulation:**

- $U_f$  values: until 1.5 W/(m<sup>2</sup>K)
- $U_w$  values: until 0.94 W/(m<sup>2</sup>K) with triple glazing

**Sealing concept:**

- Voluminous centre gasket with three installation methods
  - Circumferential centre gasket, avoiding joints in the corner areas
  - Formed corners, avoiding adhesive in the joints
  - Corner vulcanised frames

**Fittings:**

- Exterior visible turn fittings, optionally:
  - top-side application for top-hung opening
  - lateral application for side-hung opening
- Operation either manual or motorised
- Sash weight: up to 150 kg
- Sash formats (w x h): up to 2000 mm x 2000 mm



# WICLINE 65 evo/ WICLINE 75 evo Italian window (outward)

An elegant appearance combined with efficient ventilation are the characteristics of the aluminium system WICLINE evo in its Italian opening version. Concealed friction stays ensure an outward opening also for large size sashes, with a secure opening fixation in any position. Special frame profiles for punched windows or for curtain wall integration as well as a large selection of friction stay sizes guarantee maximum versatility of the system.

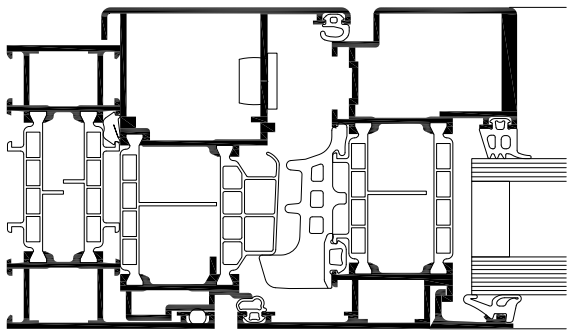

**System test results/CE product pass in accordance with DIN EN 14351-1:2006+A1:2010**

Air permeability:	Class 4
Watertightness:	E1200
Resistance to wind load:	Class C5/B5
Operating forces:	Class 1
Mechanical strength:	Class 4
Repeated opening/closing:	Class 2 (10,000 cycles)
Impact resistance:	Class 3
Quality assurance:	Certified according to ISO 9001:2008

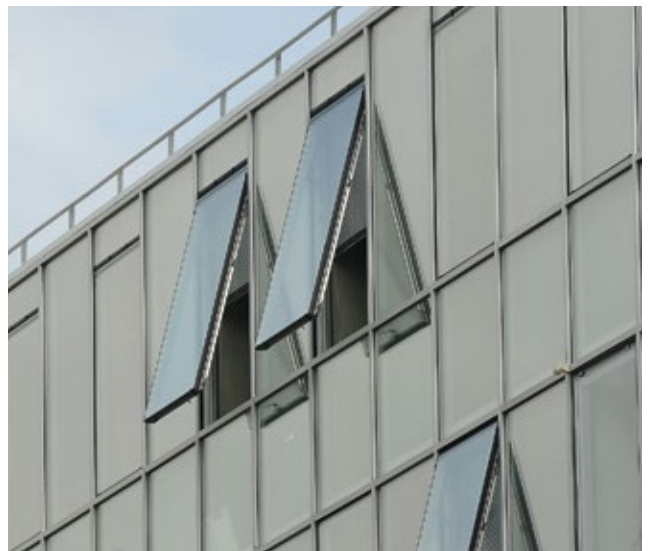

**Technical performance:**

**Profile technology:**

- High insulation multi-chamber system in symmetric design, quality assured thermal insulator connection
- Patented corner and butt joint connection technology for high rigidity of frames and sashes
- Infill thickness up to 69 mm
- Optionally with integration frame for stick system curtain walls

**Thermal insulation:**

- $U_f$  values: until 1.5 W/(m<sup>2</sup>K)
- $U_w$  values: until 1.0 W/(m<sup>2</sup>K) with triple glazing

**Sealing concept:**

- Voluminous centre gasket with formed corners

**Fittings:**

- Concealed integrated friction stay fittings, with vertical adjustment
- Operation either manual or motorised
- Sash weight: until 150 kg
- Sash formats (w x h): until 2000 mm x 2200 mm

# WICLINE 65 evo/ WICLINE 75 evo Pivot window, horizontal or vertical

A classic opening type becomes again a state-of-the-art product with WICONA technology: The horizontal and the vertical pivot windows based on the aluminium window system WICLINE evo offer improved thermal insulation, have achieved high classifications in CE-testing each, and with their option of visible or concealed fittings they are a real visual highlight for any punched or façade integrated window.

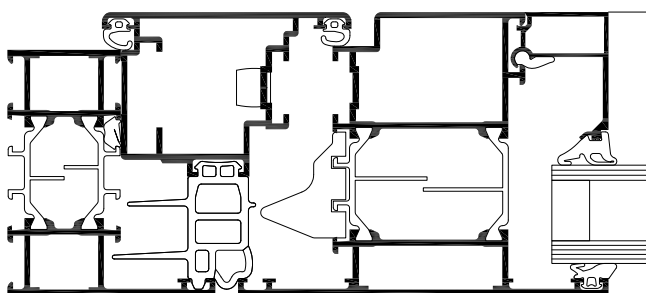

**System test results / CE product pass in accordance with DIN EN 14351-1:2006+A1:2010**

	horizontal	Vertical
Air permeability:	Class 4	Class 4
Watertightness:	E750	4A
Resistance to wind load:	Class C5/B5	Class C5/B5
Operating forces:	Class 1	Class 1
Mechanical strength:	Class 4	Class 4
Repeated opening/closing:	Class 2 (10,000 cycles)	Class 2 (10,000 cycles)
Quality assurance:	Certified according to ISO 9001:2008	

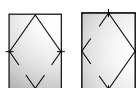

**Technical performance:**

**Profile technology:**

- High insulation multi-chamber system in symmetric design, quality assured thermal insulator connection
- Patented corner and butt joint connection technology for high rigidity of frames and sashes
- Infill thickness up to 69 mm
- Optionally with integration frame for stick system curtain walls

**Thermal insulation:**

- $U_f$  values: until 1.5 W/(m<sup>2</sup>K)
- $U_w$  values: until 1.0 W/(m<sup>2</sup>K) with triple glazing

**Sealing concept:**

- Special multi-chamber centre gasket with fins for superior tightness and improved thermal insulation

**Fittings:**

- Horizontal or vertical pivot fittings, optionally with
  - visible bearings
  - concealed bearings
- Sash weight:
  - Horizontal: up to 150 kg
  - Vertical: up to 120 kg
- Sash formats (w x h):
  - Horizontal: up to 2400 mm x 1400 mm
  - Vertical: up to 2000 mm x 2000 mm



# WICLINE 65 evo/ WICLINE 75 evo Integration sash



The ideal combination: WICTEC stick system curtain walls with integrated opening sashes from the WICLINE window series. The versatile systems with extended performances offer individual solutions on highest technical and design level, adaptable with a large selection of additional functions.

21

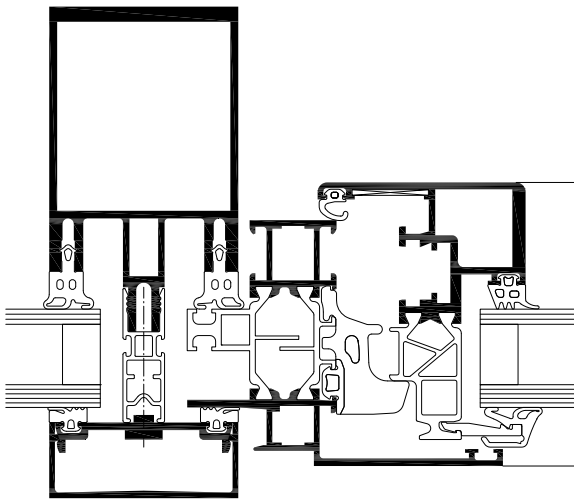

**System test results / CE product pass in accordance with DIN EN 14351-1:2006+A1:2010 and DIN EN 13830:**

See classification of the WICLINE window series and the WICTEC curtain wall series.

- 11 Example standard sash
- 21 Example concealed sash

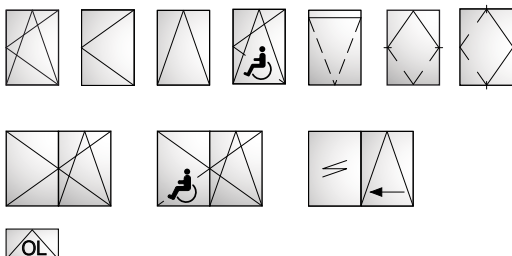

**Technical performance:**

**Profile technology:**

- High insulation multi-chamber system in symmetric design, quality assured thermal insulator connection
- Patented corner and butt joint connection technology for high rigidity of frames and sashes
- Infill thickness up to 69 mm

**Thermal insulation:**

- See values of the respective window and door series

**Inward opening options:**

- Turn / turn-tilt / tilt window
- Concealed sash
- Horizontal pivot window
- Vertical pivot window
- Burglar resistance

**Fittings:**

- Heavy duty system fittings with:
  - visible hinges, powder coating or anodization in all colours
  - concealed hinges with integrated end position damping, opening angle max. 105°
- Sash weight:
  - Concealed turn/tilt fittings: up to 160 kg
  - Visible turn/tilt fittings: up to 200 kg
  - Turn hinges (on demand): up to 300 kg
- Sash sizes (w x h): 1700 mm x 2500 mm
- Optionally with opening limiter in various executions

**Fittings, outward opening:**

- Top-hung window
- Side-hung window
- Italian window

**Fittings:**

- Visible hinges top-hung or side-hung
- Concealed hinges Italian style window
- Sash weight: up to 150 kg
- Sash sizes (w x h): up to 2000 mm x 2000 mm

# WICLINE 77IK

## Industrial design window

WICLINE 77IK industrial design is the ideal aluminium window for the renovation of historical buildings or to assign a technical look. The profile contour supports steel window design and individual adaptations like stick façade structures, crossbars in different alternatives or concealed sashes. Whether new build or renovation: WICLINE 77IK always makes it easy to fuse the various technical and design requirements.

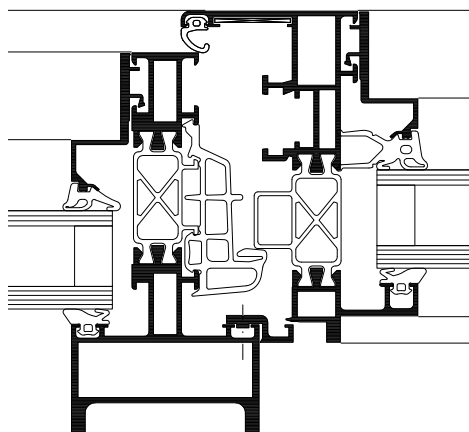

**System test results / CE product pass in accordance with DIN EN 14351-1:2006+A1:2010**

Air permeability:	Class 4
Watertightness:	9A
Resistance to wind load:	Class C5/B5
Operating forces:	Class 1
Repeated opening / closing:	Class 2 (10,000 cycles)
Quality assurance:	Certified according to ISO 9001:2008

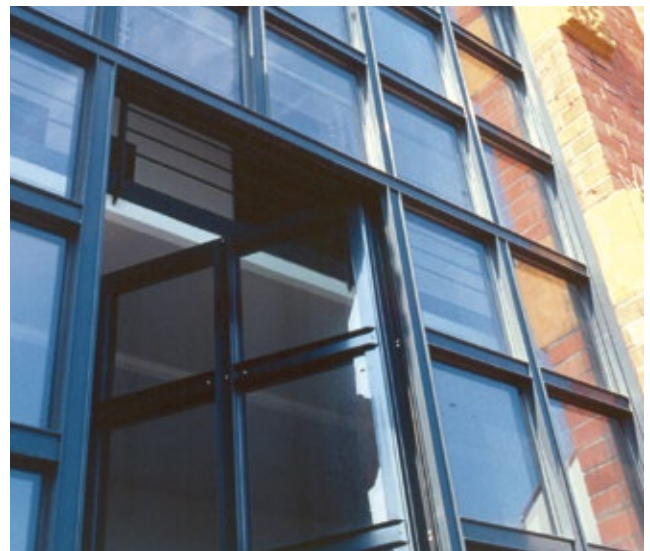

**Technical performance:**

**Profile technology:**

- High insulation multi-chamber system quality assured thermal insulator connection
- Patented corner and butt joint connection technology for high rigidity of frames and sashes
- Infill thickness up to 59 mm

**Thermal insulation:**

- $U_f$  values: until 1.4 W/(m<sup>2</sup>K)

**Sealing concept:**

- Special multi-chamber centre gasket for superior tightness and improved thermal insulation

**Fittings:**

- Concealed single-handed operated fittings, alternatively with:
  - Visible hinges
  - Concealed hinges
- Sash weight:
  - Up to 100 kg
- Sash sizes (w x h): 1300 mm x 1700 mm

**Additional options in industrial design:**

- Concealed sash
- Overlapping sash profile
- Double casement window
- Ribbon windows with split mullion
- Window units with stick curtain wall structure
- Crossbar windows with glass partitioning crossbars



# WICLINE 65N

## Non-insulated windows



The WICLINE 65N aluminium window is ideally suited for buildings in which specific heat protection measures are unnecessary. Ideal as well for the use as NSHEV (Natural Smoke and Heat Exhaust Ventilator).

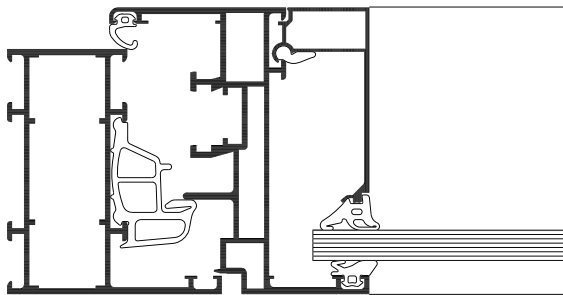

**System test results/CE product pass in accordance with DIN EN 14351-1:2006+A1:2010**

Air permeability:	Class 4
Watertightness:	9A
Resistance to wind load:	Class C5/B5
Operating forces:	Class 1
Repeated opening / closing:	Class 2 (10,000 cycles)
Burglar resistance:	WK1, WK2
Quality assurance:	Certified according to ISO 9001:2008

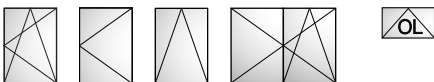

### Technical performance:

#### Profile technology:

- High quality aluminium profiles, without thermal break
- Patented corner and butt joint connection technology for high rigidity of frames and sashes
- Infill thickness up to 58 mm

#### Fittings:

- Concealed single-handed operated fittings, alternatively with:
  - Visible hinges
  - Concealed hinges
- Sash weight:
  - Up to 100 kg
- Sash sizes (w x h): 1300 mm x 1700 mm

#### Additional designs non-insulated:

- Window-doors/French doors
- NSHEV applications
- Burglar resistance

**Compatible with the door series WICSTYLE 65N non-insulated**

# WICLINE 125

## Coupled window



WICLINE 125 is a composite window system for buildings with particularly high thermal and sound insulation requirements. The interior sash is combined with an additional sash in front of it. This significantly increases the window's protective features, thermal performance and living comfort. Sun shading systems can be integrated in a weather protected way between the outer and inner sash.

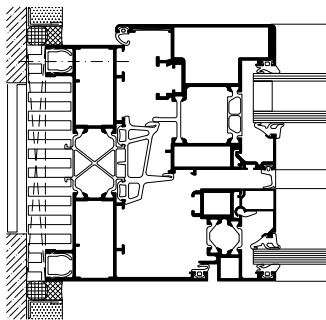

**System test results/CE product pass in accordance with DIN EN 14351-1:2006+A1:2010**

Air permeability:	Class 4
Watertightness:	E750
Resistance to wind load:	Class C5/B5
Acoustic performance:	$R_w (C;C_{tr}) = 48 (-1;-4)$ dB
Operating forces:	Class 1
Burglar resistance:	Until WK3
Quality assurance:	Certified according to ISO 9001:2008

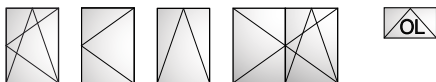

**Technical performance:**

**Profile technology:**

- Profile depths:
  - 125 mm: Frame and transom profiles
  - 136 mm: Combined sash profiles, main inner sash with overlap
- Between the two sashes a sunshade device can be integrated, protected from any weather influence and wind speeds

**Thermal insulation:**

- $U_w$  values below 0.9 W/(m<sup>2</sup>K)

**Sound insulation:**

- Sound insulation up to 48 dB

**Burglar resistance:**

- Resistance classes from WK1 to WK3 in accordance with DIN V ENV 1627 can be achieved

**Fittings:**

- Permitted sash weight (total for combined windows) up to 160 kg – Turn, turn / tilt, tilt window / fanlight

**Optional designs:**

- Outer sash – with thermal insulation
- Outer sash – concealed design
- Outer sash – industrial design
- Outer sash – all-glass window, glued

# WICLINE 215

## Hybrid window with double skin technology



High sound insulation even when the window is open?  
WICONA has found a solution for an issue that at first appears irresolvable – the WICLINE 215. A double pane window with the same structural and physical values of a double skin façade. This new type of window combines an inward opening sash with a parallel projecting sash. Both can be operated independently. This construction multiplies the user comfort in many ways: individual ventilation, and automatic control for night cooling assure the best possible room climate. A sun protection device integrated between both sashes not only ensures even greater comfort, it also reduces energy consumption.

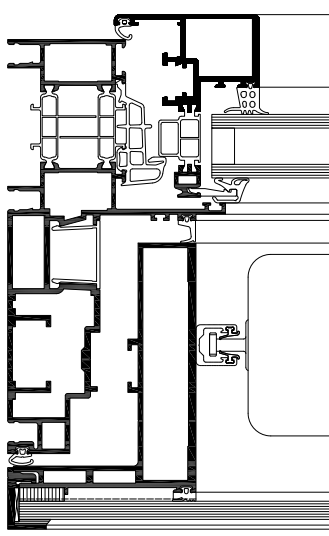

**System test results/CE product pass in accordance with DIN EN 14351-1:2006+A1:2010**

WICLINE 215 is a bespoke solution which is adapted to each individual project requirement. The respective needs are considered in the project specific testing. For further information and personal project support please contact your WICONA sales office.

**Technical performance:**

**System technology:**

- Hybrid window in double skin technology, with all its advantages: interior manual or automatised sash, exterior parallel outward opening sash
- Two sashes that can be operated individually, no restrictions in use
- Integrated sun shading device, protected against high wind speeds, dirt and weathering
- Only 215 mm system depth, despite integrated solar protection, motor assistance and control system
- Inner sash protected from burglary or weathering even when outer window is open

**Thermal insulation:**

- $U_w$  values until 0.65 W/(m<sup>2</sup>K) are feasible

**Sound insulation:**

- Superior sound insulation level with closed sashes, depending on the glazing; increased sound insulation already with open exterior and interior sash
- In combination with sound insulation glazing a protection level of 57 dB can be achieved

**Fittings:**

- Interior sash with following options: turn / turn-tilt / tilt / double casement / E-TecDrive / fanlight / burglar resistance / night cooling
- Exterior sash with motorised parallel outward opening operation

# WICLINE 75FP

## Fire protection window



The new WICLINE 75FP fire protection window completes the WICONA fire protection portfolio. The design is based 100 % on the WICLINE window series and does not change in the design from the standard application.

The single sash fire protection opening unit can be applied as punched hole window, as window with surrounding, as fixed glazing or integrated in a WICTEC 50FP fire protection stick curtain wall.

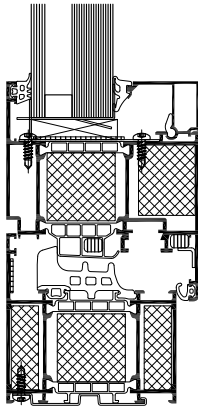

### System test results / CE product pass in accordance with DIN EN 14351-1:2006+A1:2010

Air permeability:	Class 4
Watertightness:	E750
Resistance to wind load:	Class C4 / B4
Operating forces:	Class 2
Load bearing capacity of safety devices:	Fulfilled
Mechanical strength:	Class 4
Repeated opening / closing:	Class 2 (10,000 cycles)
Impact resistance:	Class 3
Quality assurance:	Certified according to ISO 9001:2008



### Technical performance:

#### Profile technology:

- National technical approval: please contact the WICONA sales office
- Tested according to the standard DIN EN 1634
- Execution in fire protection classes EI30 or EW30
- Patented corner and butt joint connection technology for high rigidity of frames and sashes
- Infill thickness up to 43 mm
- Optionally with integration frame for stick curtain walls

#### Thermal insulation:

- $U_f$  values: until 1.6 W/(m<sup>2</sup>K)

#### Sealing concept:

- Voluminous centre gasket with three installation methods
  - Circumferential centre gasket, avoiding joints in the corner areas
  - Formed corners, avoiding adhesive in the joints
  - Corner vulcanised frames

#### Fittings:

- Heavy duty system fittings, with concealed hinges, integrated end position damping, opening angle max. 105°
- Sash weight:
  - Concealed fittings: up to 160 kg
- Sash sizes (w x h): 1170 mm x 2170 mm



# WICLINE

## Window systems

### Burglar resistance

Personal security and building protection – for your building you need a solution approach which can be accomplished with aluminium systems in a holistic and compatible way. This is achieved by the WICONA series for windows, curtain walls and doors. Each of them can be executed in burglar resistance, in combination with other additional functions. The various levels of resistance classes can be achieved with all WICLINE window series without visual alterations of the constructions, with only a minimum of additional measures on the basis of the standard design.

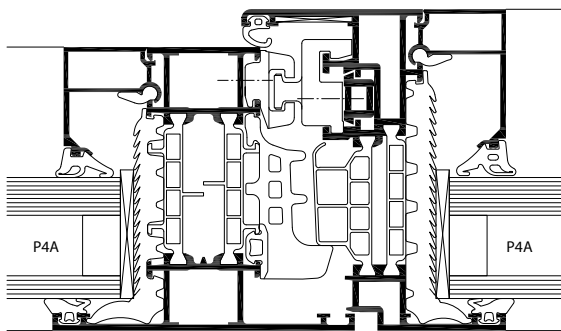

WICLINE 75 evo RC2

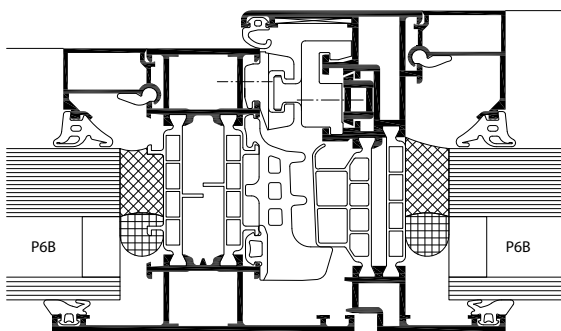

WICLINE 75 evo RC3

**System test results / CE product pass in accordance with DIN EN 14351-1:2006+A1:2010**

See classification of the respective WICLINE window series.



**Technical performance:**

**Burglar resistance according to DIN EN 1627:**

- The currently valid standard for burglar resistance, DIN EN 1627, has come into effect in European countries in 2011 and 2012. It replaced former national standards, like in Germany since September 2011 the standard DIN 1627. The classifications have been modified to classes RC1N to RC3, which are not identical with the former classes WK1 to WK3, as the test sequences have been changed.

**Test results of the WICONA window series:**

- The new WICLINE 65 evo and WICLINE 75 evo series with several variations have been tested according to the new standard DIN EN 1627. They can easily be specified and implemented without any additional measurement according to this new standard.

**Burglar resistance according to DIN EN 1627 resp. DIN 1627 / classifications:**

WICLINE 65 evo/75 evo Turn/tilt-turn/tilt/tilt-first/ double casement	RC1N, RC2N, RC2, RC3
WICLINE 65 evo/75 evo Fanlight	RC1N, RC2N, RC2, RC3
WICLINE 65 evo/75 evo Concealed sash	RC1N, RC2N, RC2, RC3
WICLINE 65 evo/75 evo Classic design	RC1N, RC2N, RC2, RC3
WICLINE 125 Coupled window	WK1, WK2, WK3

# WICLINE

## Window systems

### Bullet resistance

Personal security and building protection – for your building you need a solution approach which can be accomplished with aluminium systems in a holistic and compatible way. This is achieved by the WICONA series for windows, curtain walls and doors. Each of them can be executed in bullet resistance, in combination with other additional functions. The requirements for bullet resistance are achieved with various WICLINE window profile combinations, simply by addition of the standard construction with a special aluminium planking.

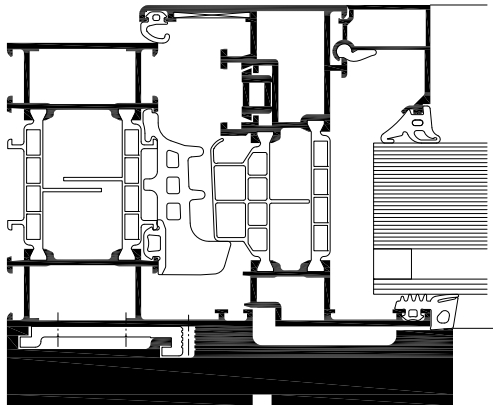

**System test results / CE product pass in accordance with DIN EN 14351-1:2006+A1:2010**

See classification of the respective WICLINE window series.



#### Technical performance:

##### Bullet resistance according to DIN EN 1522

- The bullet resistance requirements for windows are regulated Europe wide in the standard DIN EN 1522. The new window series WICLINE 65 evo and WICLINE 75 evo have been tested according to this standard in various profile combinations, and successfully been certified in class FB4 S and FB4 NS.
- Bullet resistance can be combined with burglar resistance in the classes RC1N, RC2N, RC2, RC3 according to DIN EN 1627.
- Bullet resistance in classes FB4 S and FB4 NS can be achieved for various opening types, in punched hole applications or in ribbon windows.

##### Possible combinations with other WICONA product series in bullet resistance in class FB4:

- Doors WICSTYLE 65 evo / WICSTYLE 75 evo
- Stick curtain walls WICTEC 50

##### Bullet resistance according to DIN EN 1522 / classifications:

WICLINE 65 evo / 75 evo Turn / turn-tilt / tilt / tilt-first / double casement	FB4 S / FB4 NS
WICLINE 65 evo / 75 evo Fanlight	FB4 S / FB4 NS

# WICSTYLE 65 evo

## Hinged doors



WICSTYLE 65 evo with its flush leaf design in 65 mm system depth and a comprehensive application range is perfectly qualified for highest demands in design, technological quality and performance. Due to its favourable price/performance ratio it constitutes an economical aluminium door solution for almost any requirement.

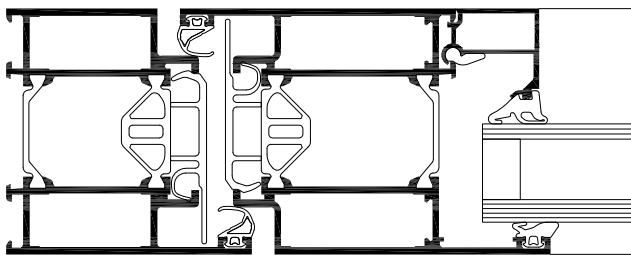

**System test results / CE product pass in accordance with DIN EN 14351-1:2006+A1:2010**

Air permeability:	Class 4
Watertightness:	Until 7A
Resistance to wind load:	Class C2
Acoustic performance:	$R_w$ (C; Ctr) until 43 (-2; -5) dB
Operating forces:	Class 2
Load bearing capacity of safety devices:	Fulfilled
Mechanical strength:	Class 3
Repeated opening / closing:	Until class 7 (500,000 cycles)
Impact resistance:	Class 1
Behaviour between different climates:	Until class 2(e) 2(d)
Burglar resistance:	RC1N, RC2N, RC2, RC3
Bullet resistance:	Until FB4
Quality assurance:	Certified according to ISO 9001:2008

Specific application data see ift product pass

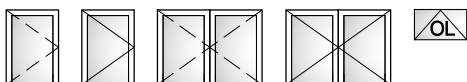

**Technical performance:**

**Profile technology:**

- High insulation multi-chamber system in symmetric design, quality assured thermal insulator connection
- For single and double leaf hinged doors
- For inward and outward opening
- For glass or panels with infill thickness from 3 mm to 50 mm
- Various threshold profiles with or without thermal break, also barrier free
- Fanlights, lateral glazings fixed or openable in combination with WICLINE evo window series

**Thermal insulation:**

- $U_f$  values: from 1.8 to 2.1 W/(m<sup>2</sup>K)
- $U_d$  values: until 1.3 W/(m<sup>2</sup>K)

**Fittings:**

- Butt hinge
- Screwed hinge
- Leaf sizes (w x h): 1400 mm x 2520 mm
- Max. leaf weight: until 200 kg, for bullet resistance with additional hinges until 400 kg

**Additional designs:**

- Double action doors
- Integration frame for stick façades
- Burglar resistance in classes RC1 to RC3
- Bullet resistance in class FB4
- Leaf overlapping infill on one side or on both sides

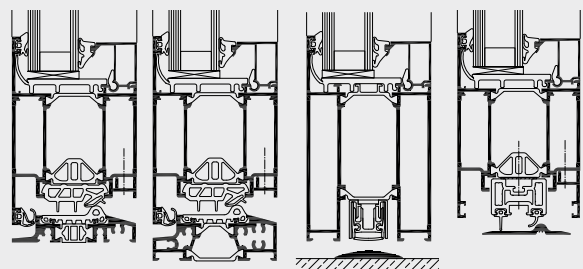

WICSTYLE threshold options

# WICSTYLE 75 evo

## Hinged door



With 75 mm profile depth, WICSTYLE 75 evo puts itself ahead in terms of thermal insulation and physical features. Its outstanding technical performance and application range make it the ideal door solution for all current and future requirements in architecture, both in new buildings and in renovations.

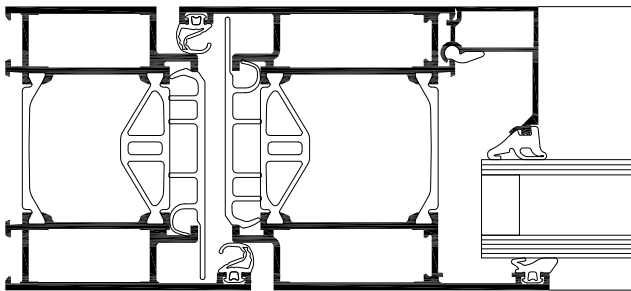

### System test results / CE product pass in accordance with DIN EN 14351-1:2006+A1:2010

Air permeability:	Until class 4
Watertightness:	Until 7A
Resistance to wind load:	Class C2
Acoustic performance:	$R_w$ (C; Ctr) until 43 (-2; -5) dB
Operating forces:	Class 2
Load bearing capacity of safety devices:	Fulfilled
Mechanical strength:	Class 3
Repeated opening / closing:	Until class 7 (500,000 cycles)
Impact resistance:	Class 1
Behaviour between different climates:	Until class 2(e) 2(d)
Burglar resistance:	RC1N, RC2N, RC2, RC3
Bullet resistance:	Until class FB4
Quality assurance:	Certified according to ISO 9001:2008

Specific application data see ift product pass

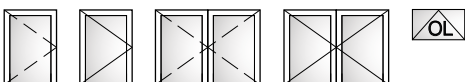

### Technical performance:

#### Profile technology:

- High insulation multi-chamber system in symmetric design, quality assured thermal insulator connection
- For single and double leaf hinged doors
- For inward and outward opening
- For glass or panels with infill thickness from 6 mm to 60 mm
- Various threshold profiles with or without thermal break, also barrier free
- Fanlights, lateral glazings fixed or opening in combination with WICLINE evo window series

#### Thermal insulation:

- $U_f$  values: from 1.6 to 1.8 W/(m<sup>2</sup>K), without foam inserts

#### Fittings:

- Butt hinge
- Screwed hinge
- Concealed hinge\*
- Leaf sizes (w x h): 1200 mm x 2520 mm
- Max. leaf weight: until 200 kg, for bullet resistance with additional hinges until 400 kg

#### Additional designs:

- Double action doors
- Integration frame for stick façades
- Burglar resistance in classes RC1 to RC3
- Bullet resistance in class FB4
- Leaf overlapping infill on one side or on both sides

\*on demand

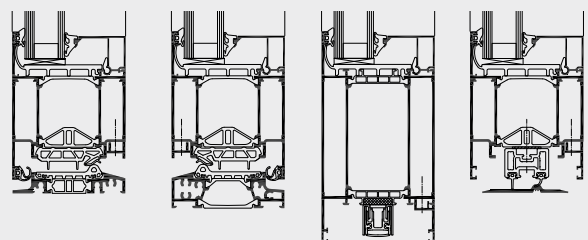

WICSTYLE threshold options



# WICSTYLE 65 evo / WICSTYLE 75 evo Classic design



Bevelled profile contours and overlapping sashes are characteristic for the aluminium door series WICSTYLE evo in classic design. This design underlines a style which is often requested for residential architecture. Ideal for new building and for energetic renovations alike.

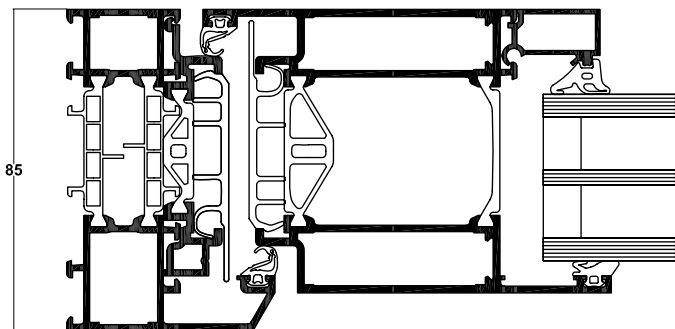

**System test results / CE product pass in accordance with DIN EN 14351-1:2006+A1:2010**

Air permeability:	Until class 4
Watertightness:	Until 7A
Resistance to wind load:	Class C2
Acoustic performance:	$R_w$ (C; Ctr) until 43 (-2; -5) dB
Operating forces:	Class 2
Load bearing capacity of safety devices:	Fulfilled
Mechanical strength:	Class 3
Repeated opening / closing:	Until class 7 (500,000 cycles)
Impact resistance:	Class 1
Behaviour between different climates:	Until class 2(e) 2(d)
Burglar resistance:	RC1N, RC2N, RC2, RC3
Quality assurance:	Certified according to ISO 9001:2008

Specific application data see ift product pass

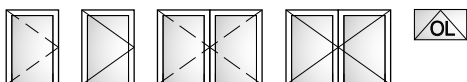

**Technical performance:**

**Profile technology:**

- High insulation multi-chamber system in symmetric design, quality assured thermal insulator connection
- For single and double leaf hinged doors
- For inward and outward opening
- For glass or panels with infill thickness from 3 mm to 60 mm
- Various threshold profiles with or without thermal break, also barrier free
- Fanlights, lateral glazings fixed or opening in combination with WICLINE evo window series

**Thermal insulation:**

- $U_f$  values: from 1.6 to 1.8 W/(m<sup>2</sup>K), without foam inserts

**Fittings:**

- Butt hinge
- Screwed hinge
- Concealed hinge\*
- Leaf sizes (w x h): 1400 mm x 2520 mm,
- Max. leaf weight: until 200 kg

**Additional designs:**

- Double action doors
- Integration frame for stick façades
- Burglar resistance in classes RC1 to RC3

\*on demand

# WICSTYLE 65 evo / WICSTYLE 75 evo Finger protection door



Save operation through efficient prevention of squeezing or shearing risks on the hinge side, combined with the technical performance of the WICSTYLE aluminium door systems: WICSTYLE 65 evo and WICSTYLE 75 evo finger protection doors offer a maximum of advantages in one solution.

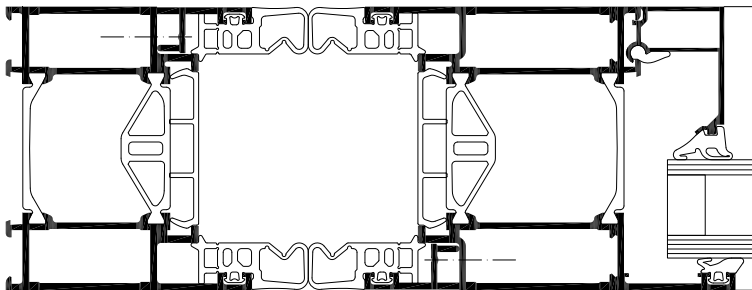

**System test results / CE product pass in accordance with DIN EN 14351-1**

Air permeability:	Class 2
Watertightness:	Until 6A
Resistance to wind load:	Class C2
Operating forces:	Class 2
Load bearing capacity of safety devices:	Fulfilled
Mechanical strength:	Class 3
Repeated opening / closing:	Until class 7 (500,000 cycles)
Impact resistance:	Class 1
Behaviour between different climates:	Until class 2(e) 2(d)
Quality assurance:	Certified according to ISO 9001:2008

Specific application data see ift product pass

**Technical performance:**

**Profile technology:**

- Finger protection on the hinge side is effected only by special gaskets. No other additional parts are needed.
- The requirements of the standard DIN 18650 (safety distance > 25 mm) are met.
- High insulation multi-chamber system in symmetric design, quality assured thermal insulator connection
- For single and double leaf hinged doors
- For inward and outward opening
- For glass or panels with infill thickness from 3 mm to 60 mm
- Various threshold profiles with or without thermal break, also barrier free
- Fanlights, lateral glazings fixed or opening in combination with WICLINE evo window series

**Thermal insulation:**

- $U_i$  values: from 1.6 to 1.8 W/(m<sup>2</sup>K), without foam inserts

**Fittings:**

- Butt hinge
- Screwed hinge
- Leaf sizes (w x h): 1400 mm x 2520 mm
- Max. leaf weight: until 200 kg

**Additional designs:**

- Double action doors
- Integration frame for stick façades

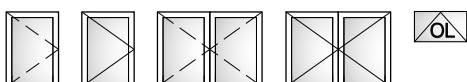

# WICSTYLE 65 evo

## Double action door



The WICSTYLE 65 evo serie offers two profile options for single and double sash doors with double action fitting. Both versions are based on the standard door serie and can perfectly be combined with it.

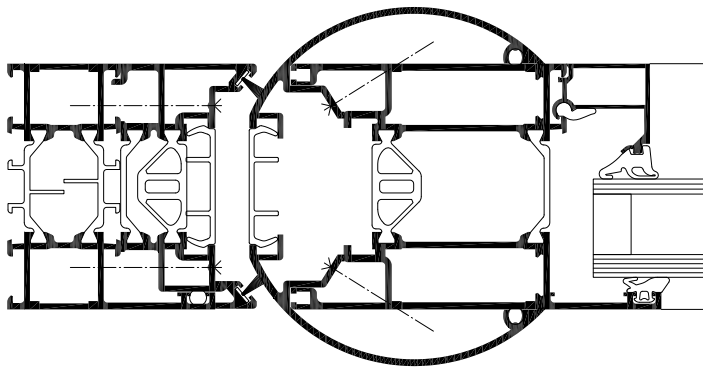

With round profile, fulfils also the finger protection requirements

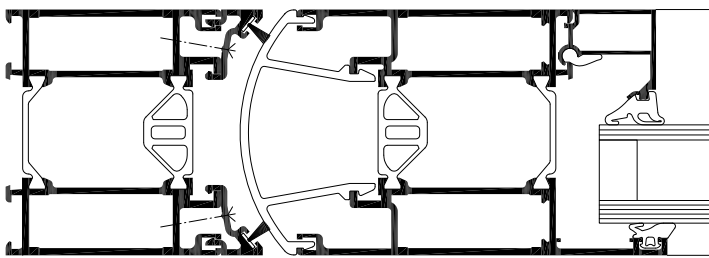

Flush surface door

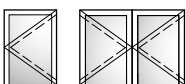

### Technical performance:

#### Profile technology:

- High insulation multi-chamber system in symmetric design, quality assured thermal insulator connection
- For single and double leaf double action doors
- For glass or panels with infill thickness from 3 mm to 50 mm
- Various threshold profiles, also barrier free
- Fanlights, lateral glazings fixed or opening in combination with WICLINE evo window series

#### Fittings:

- With overhead door closer
- With floor spring\*
- Leaf sizes (w x h): 1300 mm x 2300 mm
- Max. leaf weight: until 160 kg

#### Additional designs:

- Integration frame for stick façades

\*on demand

# WICSTYLE 65 evo

## All-glass doors

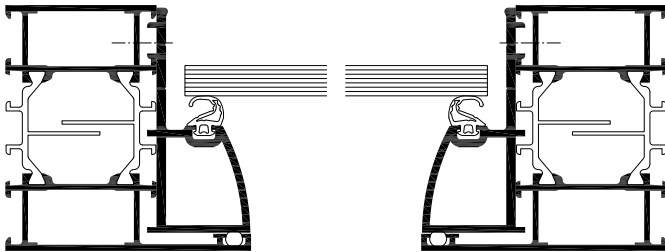

All-glass doors create maximum transparency in a building. WICSTYLE all-glass doors are based on the standard WICSTYLE 65 evo serie, with many identical parts, and thus offer optimal compatibility with other door solutions within the building.

**Technical performance:****Profile technology:**

- High quality profile system in symmetric design
- For single and double leaf hinged doors
- For inward and outward opening
- For glass doors with 8 mm or 10 mm glass
- Fanlights, lateral glazings fixed or opening

**Fittings:**

- Fittings for standard glass doors with 45 kg or 55 kg leaf weight

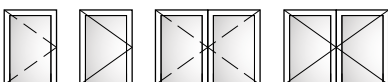

# WICSTYLE 50N / 65N

## Hinged doors, non-insulated

These aluminium systems are designed specially for use inside buildings or where thermal insulation is not a determining factor. The ranges also meet high standards with regard to functionality, durability and comfort, whilst providing good economy.

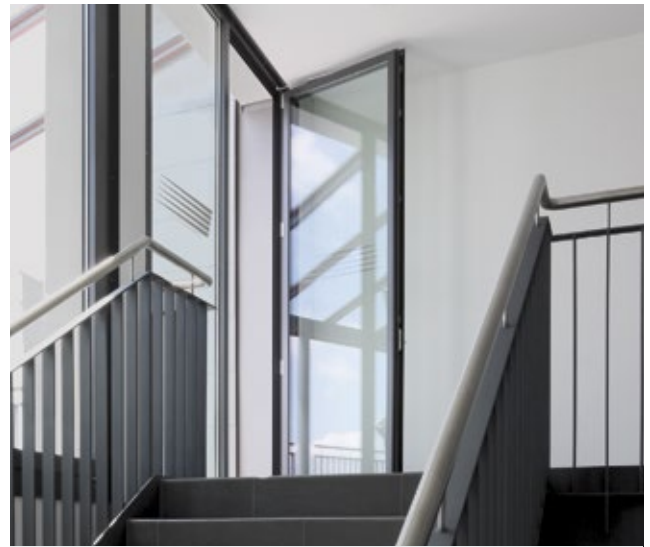
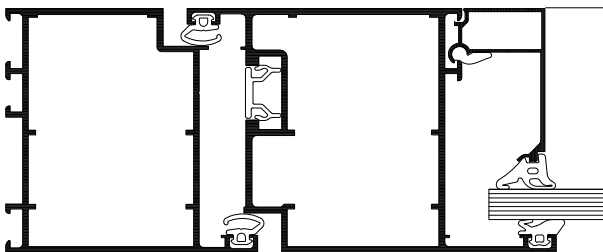
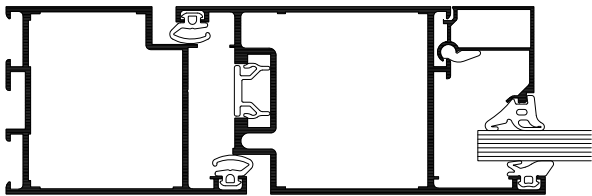

### Technical performance:

#### Profile technology:

- High quality profiles with profile depth 50 mm or 65 mm
- For single and double leaf hinged doors with flush leaf profiles
- For inward and outward opening
- Option of glass-separating or adhesive sash bars
- Fanlights, lateral glazings fixed or opening in combination with WICLINE evo window series
- With mechanical floor gasket or stop gasket
- With butt-hinge or screwed hinge

#### Special for WICSTYLE 50N:

- Infill thickness 4 mm to 31 mm
- Leaf weight until 150 kg
- Max. leaf size (w x h): until 1300 mm x 2700 mm

#### Special for WICSTYLE 65N:

- Infill thickness 4 mm to 46 mm (flush leaf) or 8 mm to 57 mm (overlapping leaf)
- Leaf weight until 200 kg
- Max. leaf size (w x h): until 1450 mm x 2350 mm

#### Additional designs:

- WICSTYLE 65N also possible as smoke control door and with burglar resistance in resistance classes WK1 and WK2

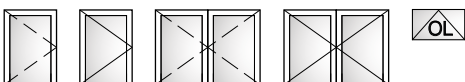

# WICSTYLE 77FP

## Fire protection door

### EI30/T30 and EI60/T60

This aluminium door in modular set-up fulfils the requirements of class EI30 and/or class T30/F30 for single and double-leaf doors without the need for fire protection inserts. Simply by adding these, class EI60 and/or T60/F60 are achieved. A full range of fanlight or fixed top or lateral glazings assure a comprehensive application range.

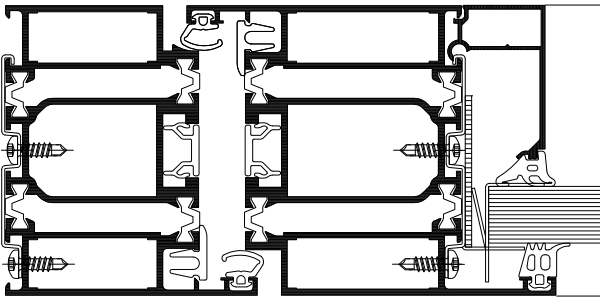

Approval in accordance with national regulations:  
Please contact your WICONA sales office.



#### Technical performance:

##### Profile technology:

- WICSTYLE 77FP is approved for the German market, for other countries the national regulations must be respected.
- Tested according to standards DIN 4102 and DIN EN 13501-2
- Execution in fire protection classes EI30/T30/F30 without fire protection inserts
- Execution in fire protection classes EI60/T60/F60 simply by adding fire protection inserts
- For single and double leaf hinged doors, inward and outward opening
- Fixed glazings, lateral lights and fanlights possible in many options
- Identical profile elevation as in the door series WICSTYLE 65 evo and WICSTYLE 75 evo, allowing for a unique design in a building project

##### Fittings:

- Butt hinge or screwed hinges in the same design as for WICSTYLE standard series, leading to a harmonised building design
- Extensive fittings for requirements such as panic functions, emergency exit seals, electric safety locks, electronic openers, revolving door drive with magnet and bolt contact
- Big unit sizes possible: (w x h) until 1362 mm x 2500 mm (single leaf), or 2500 mm x 2500 mm (double leaf)
- Max. leaf weight: until 200 kg

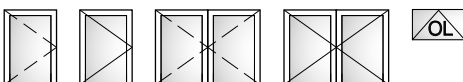

# WICSTYLE 90FP

## Fire protection door

### T90/F90

WICSTYLE FP90 is delivered as a pre-assembled component and offers very high fire resistance of 90 minutes as a single or double-leaf hinged door. This is also available in combination with fixed glazing. The door is designed for internal use, opening inward and outward. In individual cases, outdoor is possible after consultation.

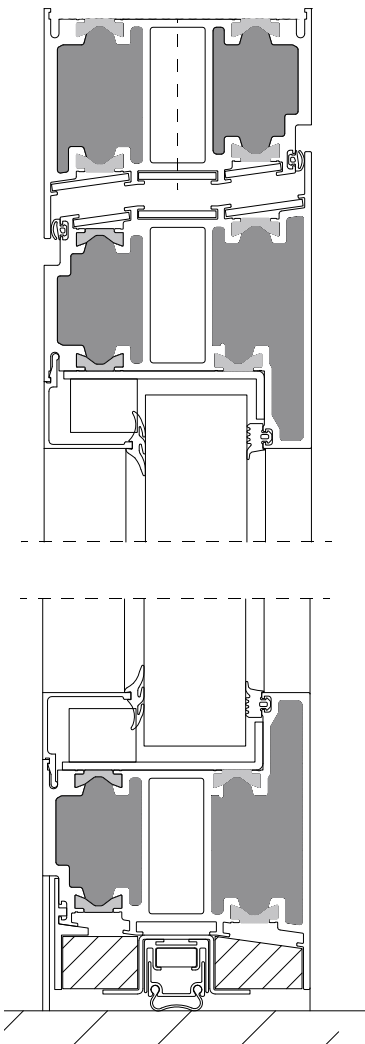

Hinged door, outward opening. Special frame with surrounding leaf profile and lowering gasket. Approval in accordance with national regulations: Please contact your WICONA sales office.

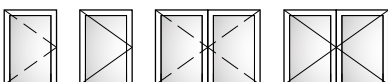

#### Technical performance:

##### Profile technology:

- WICSTYLE 90FP is approved for the German market. For other countries the national regulations must be respected.
- Pre-assembled fire protection system, doors are ready to install and include glass
- Execution in fire protection classes T90/F90
- For indoor application, inward and outward opening, and fixed glazing
- Fixed glazings, lateral lights and fanlights possible in many options
- Slim profile dimensions for filigree design
- Flush leaf with profile depth 100 mm
- Free choice for surface treatment
- Additional functions possible with large fitting portfolio



# WICSTYLE

## Door systems

### Burglar resistance

Personal security and building protection – for your building you need a solution approach which can be accomplished with aluminium systems in a holistic and compatible way. This is achieved by the WICONA series for windows, curtain walls and doors. Each of them can be executed in burglar resistance, in combination with other additional functions.

The various levels of resistance classes can be achieved with all WICSTYLE door series without visual alterations of the constructions, with only a minimum of additional measures on the basis of the standard design.

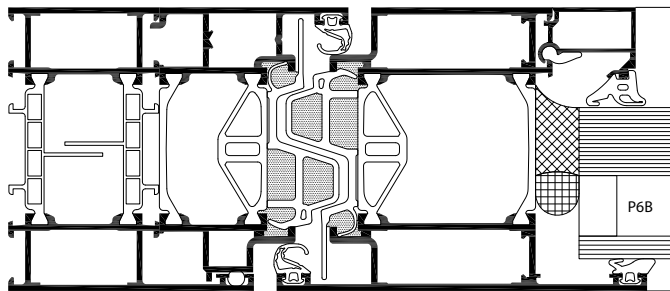

WICSTYLE 65 evo in class RC2

**System test results / CE product pass in accordance with DIN EN 14351-1**

See classification of the respective WICSTYLE door series



**Technical performance:**

**Burglar resistance according to DIN EN 1627:**

- The currently valid standard for burglar resistance, DIN EN 1627, has come into effect in European countries in 2011 and 2012. It replaced former national standards. The classifications have been modified to classes RC1N to RC3, which are not identical with the former classes WK1 to WK3, as the test sequences have been changed.

**Test results of the WICONA door series:**

- The new WICSTYLE 65 evo and WICSTYLE 75 evo door series with several variations have been tested according to the new standard DIN EN 1627. They can easily be specified and implemented without any additional measurement according to this new standard.

**Burglar resistance according to DIN EN 1627 resp. DIN 1627 / classifications:**

WICSTYLE 65 evo / 75 evo Hinged doors	RC1N, RC2N, RC2, RC3
WICSTYLE 65 evo / 75 evo Classic design	RC1N, RC2N, RC2, RC3
WICSTYLE 65N, non-insulated	WK1, WK2
Quality assurance:	Certified according to ISO 9001:2008



# WICSTYLE

## Door systems

### Bullet resistance

Personal security and building protection – for your building you need a solution approach which can be accomplished with aluminium systems in a holistic and compatible way. This is achieved by the WICONA series for windows, curtain walls and doors. Each of them can be executed in bullet resistance, in combination with other additional functions. The requirements for bullet resistance are achieved with various WICSTYLE door profile combinations, simply by addition of the standard construction with a special aluminium planking.

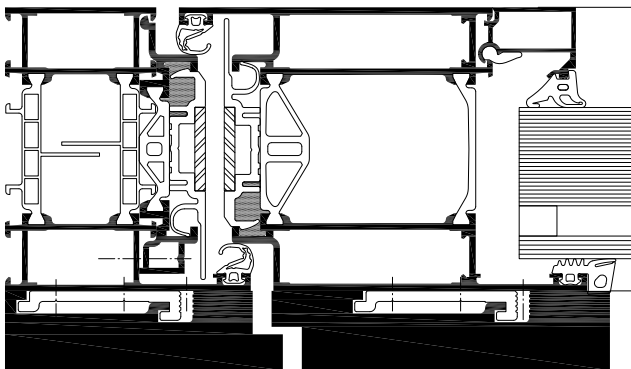

WICSTYLE 75 evo in class FB4

**System test results / CE product pass in accordance with DIN EN 14351-1**

See classification of the respective WICSTYLE door series

#### Technical performance:

##### Bullet resistance according to DIN EN 1522

- The bullet resistance requirements for doors are regulated Europe wide in the standard DIN EN 1522. The new door series WICSTYLE 65 evo and WICSTYLE 75 evo have been tested according to this standard in various profile combinations, and successfully been certified in class FB4 S and FB4 NS.
- Bullet resistance can be combined with burglar resistance in the classes RC1N, RC2N, RC2, RC3 according to DIN EN 1627.

##### Possible combinations with other WICONA product series in bullet resistance in class FB4:

- Windows WICLINE 65 evo / WICLINE 75 evo
- Stick curtain walls WICTEC 50

##### Bullet resistance according to DIN EN 1522 / classifications:

WICSTYLE 65 evo /  
WICSTYLE 75 evo  
Hinged doors, single  
or double leaf, inward  
or outward opening

FB4 S / FB4 NS

# WICSTYLE

## Door systems

### Emergency exit

---

---

---

---

In panic situations the safety and rescue possibilities for people in the building are the main concern. In Europe uniform standards for emergency exit door fittings are in application. Within the meaning of these standards, emergency exit door systems are subdivided in emergency exit devices according to EN 179, and panic door exit devices according to EN 1125. Emergency exits acc. to EN 179 are designated to buildings to which the general public does not have access and whose visitors understand the function of the emergency doors.

Panic door exit devices acc. to EN 1125 are used in public buildings where the visitors are not familiar with the function of emergency doors, like schools, hospitals, shopping malls. The WICSTYLE door systems offer a comprehensive range of applications, which can also be combined with other functions and design options.

#### **WICSTYLE systems for exit doors according to EN 179 (emergency exit device) and according to EN 1125 (panic exit device)**

WICSTYLE 65 evo hinged door

WICSTYLE 75 evo hinged door

WICSTYLE evo classic design

WICSTYLE evo finger protection door

WICSTYLE 65 non-insulated

WICSTYLE 77FP fire protection door



#### **Technical performance:**

##### **Profile technology:**

- Doors in accordance with EN 179 (emergency exit devices) or with EN 1125 (panic exit devices)
- Many system options for the emergency application, allowing for a unified door design within the building, irrespective of additional functions
- Single or double leaf possible
- Combination with burglar resistance in classes RC1 and RC2 possible
- Execution in combination with fire protection in classes T30 and T60 and in combination with smoke control possible (national regulations must be respected)



# WICSTYLE 65ED

## Energy-saving automatic sliding door



WICSTYLE 65ED, the energy-saving automatic sliding door for commercial buildings, was developed in collaboration with the Swiss global market leader Gilgen Door Systems AG, on the basis of the WICSTYLE 65 profile. Automatic sliding doors have short open and close cycles that have been optimised for throughput. Therefore, when in operation they retain the largest amount of warmth within the building. A major role in energy efficiency, however, is played by the time in which the door remains permanently shut – such as overnight. During such periods, in particular, WICSTYLE 65ED protects the building reliably against excessive energy loss, thereby making a significant contribution to improving the overall energy balance of the building.

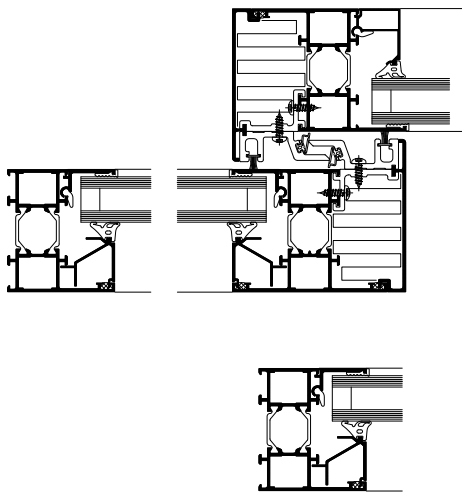

### System test results / CE product pass in accordance with DIN EN 14351-1

Air permeability:	Class 2
Watertightness:	5A
Resistance to wind load:	Class B1
Quality assurance:	Certified according to ISO 9001:2008

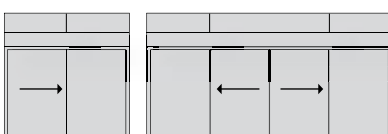

### Technical performance:

#### Profile technology:

- Safety tested in accordance with the personal safety regulations in standard DIN 18650
- Approved complete door device (both thermally insulated profile system and drive unit), according to DIN EN 14351-1
- Leading thermal insulation values with  $U_d$  values below  $1.5 \text{ W}/(\text{m}^2\text{K})$
- Up to 70 % less energy loss in closed situation
- Improved tightness compared to surrounding double gaskets in labyrinth application, with values comparable to residential entrance doors
- Reliable automation by Gilgen Door Systems
- Ideal for both new builds and renovations
- Attractive appearance due to narrow sight lines and coordinated integration of the door drive
- Infill thickness from 24 mm to 27 mm
- Option of single or double-leaf sliding versions, with or without lateral glazing
- Easy integration of additional functions and fittings, such as multipoint locks for increased burglar resistance

#### Thermal insulation:

- $U_d$  values: below  $1.5 \text{ W}/(\text{m}^2\text{K})$

#### Drive system / fittings:

- Single or double leaf door devices
- Drive systems SLA, SLX and SLX redundant
- Possible for emergency exits
- Infill weights: until 150 kg
- Leaf formats (w x h): until 2000 mm x 3000 mm



# WICSLIDE 160

## Lifting sliding doors

The new WICSLIDE 160 lifting sliding system combines excellent thermal insulation with highest functionality and design. Impressive leaf dimensions and enduring operation comfort are your guarantors for maximum customer satisfaction. With state-of-the-art technology and innovative advantages in fabrication WICSLIDE 160 is a high-tech product that sets new standards.

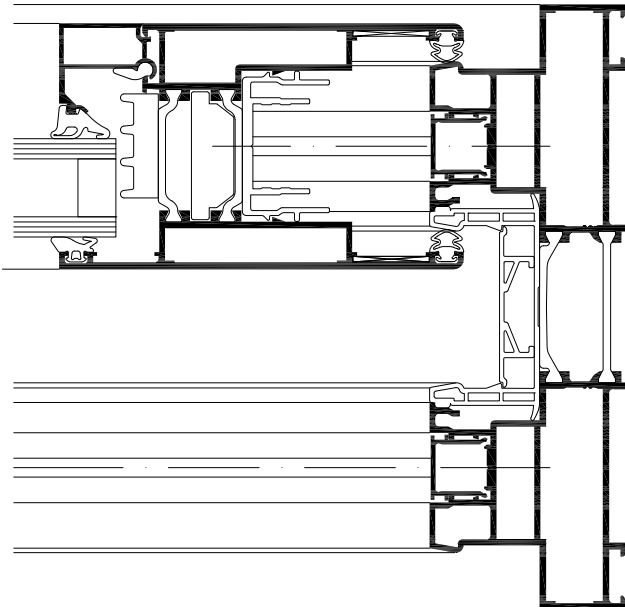

**System test results / CE product pass in accordance with DIN EN 14351-1**

Air permeability:	Class 4
Watertightness:	E1350A
Resistance to wind load:	Class C3
Quality assurance:	Certified according to ISO 9001:2008

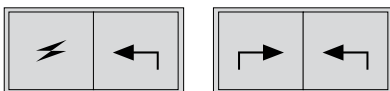

**Technical performance:**

**Profile technology:**

- Improved hooking zone between the leaves for enhanced thermal insulation and tightness
- Construction depth 160 mm (double track)
- Special frame profiles with multi function zone
- Barrier free threshold possible
- Enduring comfort operation due to optimised running carriage technology
- Hooking zone without visible screws
- Optional with fixed glazing or fixed sash
- Easy integration in WICTEC 50 and WICTEC 60 stick system curtain walling

**Thermal insulation:**

- $U_w$  values: below 1.1 W/(m<sup>2</sup>K)

**Fittings:**

- Lifting sliding fittings, running carriage with integrated brush for permanent cleaning of the tracks
- Support device in the lowering of the leaf, resulting in reduced operation forces
- Lock plates with DPS technology (Direct Positioning System)
- Leaf dimensions (w x h): until 3240 mm x 3400 mm
- Leaf weight until 400 kg (lifting sliding)



# WICSLIDE 23

## Lifting sliding doors

The special characteristics of WICSLIDE 23 make this sliding and lifting/sliding door a favourite for use as a partition. The construction can be executed with very high leaf weights of up to 300 kg. WICSLIDE 23 is weather-resistant for outdoor use and is very well suited to conservatories, swimming pools and construction projects with large expanses of glass. It can also be used in industrial construction.

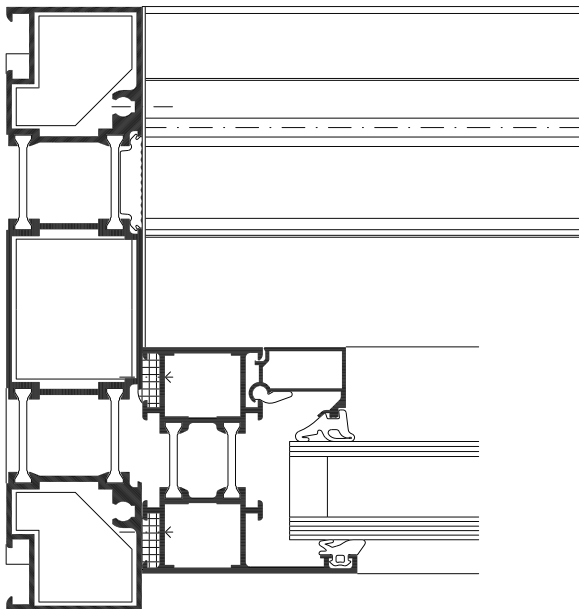

**System test results / CE product pass in accordance with DIN EN 14351-1**

Air permeability:	Class 4
Watertightness:	9A
Resistance to wind load:	Class C3/B5
Operating forces:	Class 1
Burglar resistance:	Until WK2
Repeated opening / closing:	Class 2 (10,000 cycles)
Quality assurance:	Certified according to ISO 9001:2008

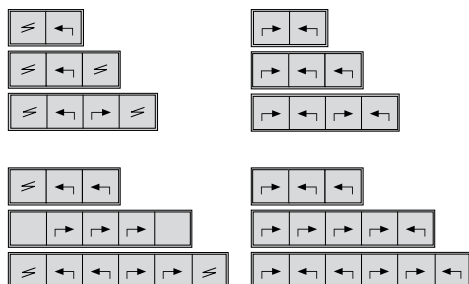

**Technical performance:**

**Profile technology:**

- Double or triple-leaf frames with compact dimensions of 160 mm (double track) or 240 mm (triple track), leaf 60 mm
- Infill thickness from 4 mm to 42 mm
- Extensive freedom of design with 2 to 6 leaves
- Combination with fixed panels or fixed leaves possible
- Easy integration in WICTEC 50 and WICTEC 60 stick system curtain walling

**Thermal insulation:**

- $U_w$  values: until 1.3 W/(m²K)

**Fittings:**

- Lifting/sliding doors or windows, or sliding doors or windows
- Leaf dimensions (w x h): until 3500 mm x 2600 mm
- Leaf weight until 300 kg



# WICSLIDE 26

## Lifting sliding doors



WICSLIDE 26 is a sliding door or lifting/sliding door which is principally used as a room partition and as exit to balconies. For these applications in particular, this range impresses as a delicate solution with a corresponding refined look. In addition, WICSLIDE 26 can also be used for structures in industry construction.

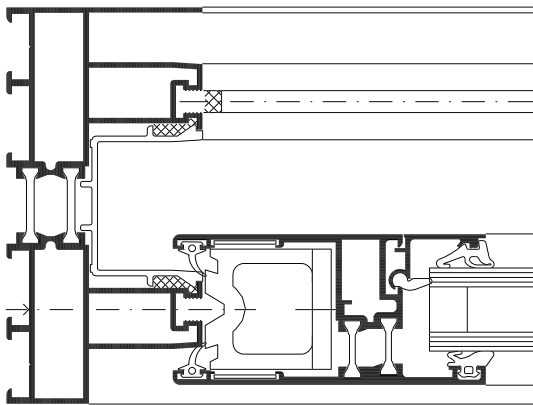

**System test results / CE product pass in accordance with RAL GZ695 / DIN EN 14351-1**

	Lifting/sliding	Sliding
Air permeability:	Class 4	Class 3
Watertightness:	9A	7A
Resistance to wind load:	Until Class C3/B3	Until Class C3/B3
Operating forces:	Class 1	Class 1
Impact resistance:	Class 5	Class 5
Burglar resistance:	Until WK2	Until WK2
Repeated opening / closing:	Class 2 (10,000 cycles)	Class 2 (10,000 cycles)
Quality assurance:	Certified according to ISO 9001:2008	

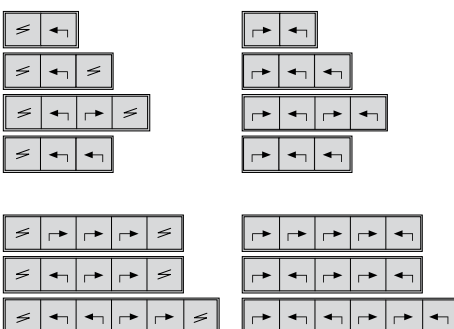

**Technical performance:**

**Profile technology:**

- Double or triple-leaf frames with compact dimensions of 105 mm (double track) or 160 mm (triple track), leaf 40 mm
- Infill thickness from 5 mm to 24 mm
- Extensive freedom of design with 2 to 6 leaves
- Combination with fixed panels or fixed leaves possible
- Easy integration in WICTEC 50 and WICTEC 60 stick system curtain walling

**Thermal insulation:**

- U<sub>w</sub> values: until 1.6 W/(m²K)

**Fittings:**

- Lifting/sliding doors or windows, or sliding doors or windows
- Leaf dimensions (w x h): until 2450 mm x 2100 mm
- Leaf weight until 150 kg

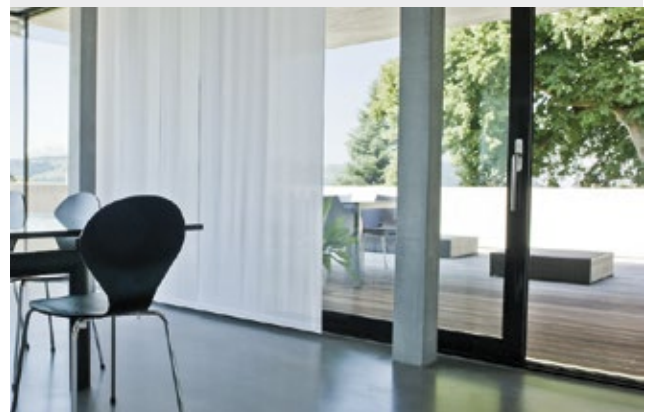

# WICSLIDE 65FS

## Folding / sliding doors

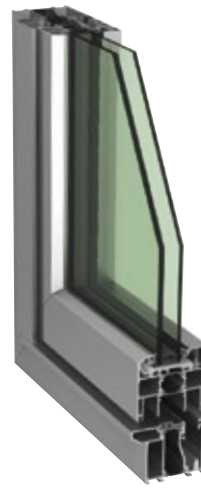

WICSLIDE 65FS is the ideal solution when there is only limited room for the opened elements. Due to its excellent technical values, WICSLIDE 65FS can be used as a direct partition, for example in conservatories, meeting areas, conference rooms, car show rooms and hotels.

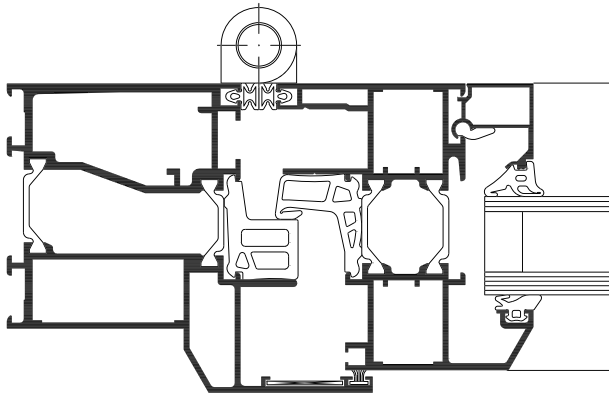

**System test results / CE product pass in accordance with DIN EN 14351-1**

	Outward opening	Inward opening
Air permeability:	Class 4	Class 3
Watertightness:	9A	7A
Resistance to wind load:	Until Class C3/B3	Until Class C2/B2
Operating forces:	Class 1	Class 1
Mechanical strength:	Class 4	Class 4
Repeated opening / closing:	Class 2 (10,000 cycles)	Class 2 (10,000 cycles)
Quality assurance:	Certified according to ISO 9001:2008	

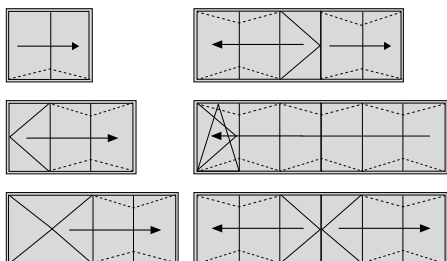

### Technical performance:

#### Profile technology:

- Slim profile construction with only 65 mm profile depth
- Infill thickness from 3 mm to 47 mm
- Folding / sliding opening type with 2 to 7 leaves, partition to the left or to the right
- Reduced space requirement for open leaves
- Easy and safe operation
- Possible with barrier free threshold for undisturbed passage

#### Thermal insulation:

- $U_w$  values: until 1.3 W/(m<sup>2</sup>K)

#### Fittings:

- Folding sliding doors with single or double turn sash
- Integrated turn/tilt or tilt sashes possible
- Leaf dimensions (w x h): until 1100 mm x 2500 mm
- Leaf weight until 100 kg



# WICSLIDE 24E WICSLIDE 24EN Sliding doors / windows

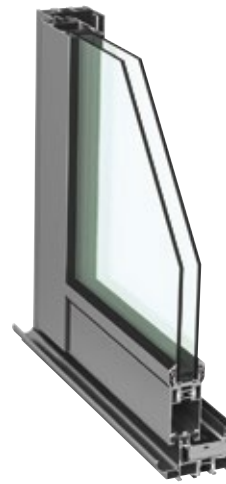

WICSLIDE 24E is used as a classic sliding window or as a sliding door with slim frame design. The choice between thermally insulated and non-insulated options allows for an ideal adaptation to each application. In the double or triple-track design, structures with up to six leaves and very large opening widths are possible.

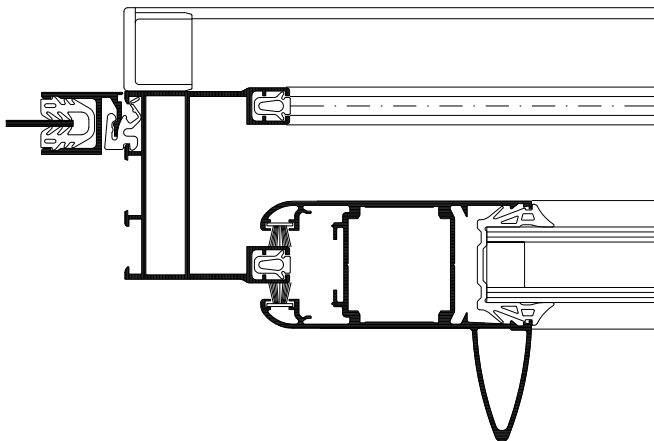
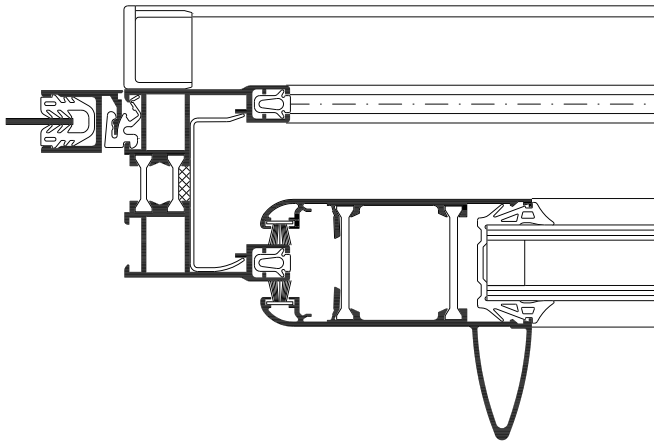

**Technical performance:**

**Profile technology:**

- Double or triple-leaf frames with compact dimensions of 50 mm (double track) or 92 mm (triple track), leaf 34 mm
- Infill thickness from 8 mm to 24 mm
- Slim frame design
- Identical design for thermally insulated and non-insulated version

**Fittings:**

- Sliding doors / windows
- 2 to 6 leaves
- Leaf dimensions (w x h): until 1800 mm x 2500 mm
- Leaf weight until 120 kg





# WICSOLAIRE

## Solar shading system

Modern architecture with extended glazed building skins offer increased energy gains from daylight, but require an external light control that aligns energy savings, user comfort and economy. WICSOLAIRE sunshading systems guide daylight into the building and thus reduce the need for artificial light. They control the energy and heat input by solar radiation and reduce the need for air conditioning.

The visual contact with the exterior remains and improves the sensation of comfort. As a passive technology WICSOLAIRE can be adapted in diverse options to the individual requirements and the architectural style of the building. In combination with the WICONA window and curtain wall systems a consistent solution is achieved.

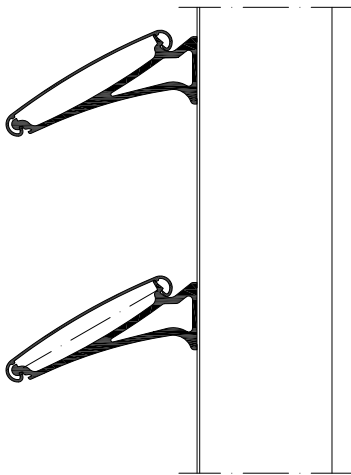

### Technical performance:

#### WICSOLAIRE Small blades

- Profile depth 100 mm or 150 mm
- Blade holders for fixture in 4 angles (15° / 30° / 45° / 60°)
- Application vertical, sloped or horizontal
- Orientation of the blades horizontally or vertically
- Easy assembly due to special fixture parts for every application

#### WICSOLAIRE Large blades

- Easy adaptation in size, assembly, application and orientation individually to each project's requirements
- Fixture at angles from 0° to 45°
- Application vertical, sloped or horizontal
- Orientation of the blades horizontally or vertically
- Easy assembly due to special fixture parts for every application

#### WICSOLAIRE with photovoltaic cells

- The integration of photovoltaic units turn a passive sunshading system into an active solar power station
- Blade module size 185 mm x 1200 mm
- Orientation in various angles to the sun, so that a maximum energy efficiency is achieved



**WICONA Sales offices****Germany**

Söflinger Straße 70  
89077 Ulm  
Telefon +49 731 3984-0  
www.wicona.de

**Switzerland**

Gewerbepark  
Postfach 30  
5506 Mägenwil  
Telefon +41 62 88741-41  
www.wicona.ch

**Austria**

Wallerseestraße 49  
5201 Seekirchen  
Telefon +43 6212 2000  
www.wicona.at

**Sweden**

Grusåsvägen 10  
352 45 Växjö  
Phone +46 470 78 74 00  
www.wicona.se

**Denmark**

Lene Haus Vej 21  
7430 Ikast  
Phone +45 70 20 20 48  
www.wicona.dk

**Norway**

Drammensveien 260  
0283 Oslo  
Phone +47 22 42 22 00  
www.wicona.no

**Poland**

ul. Mińska 63A  
03-828 Warszawa  
Phone +48 22 3308170  
www.wicona.com

**Russia**

RUS-123317, Россия, Москва  
ул. Тестовская, д. 10  
«Москва-Сити»  
БЦ «Северная башня»  
Тел. +7 917 5659559  
www.wicona.ru

**Estonia / Latvia / Lithuania**

Pärnu mnt. 139 f  
11317, Tallinn  
Phone +37 2657 6635  
www.wicona.com

**Czech Republic**

Holandská 8  
63900 Brno  
Phone +420 (0) 543 422030  
www.wicona.cz

**Hungary**

Graphisoft Park, Záhony u 7.  
1031 Budapest  
Phone +36 (1) 4533457  
www.wicona.at

**France**

Rue Jean-Baptiste Godin  
Parc d'Activités Le Plateau  
02200 Courmelles  
Téléphone +33 3 23 59 82 00  
www.wicona.fr

**Benelux**

Nijverheidsstraat 48 E  
2260 Oevel  
Telefoon +32 14 24 99 99  
www.wicona.be

**Italia**

Via Amilcare Ponchielli, 3  
20063 Cernusco sul Naviglio MI  
Telefono +39 02 92 4291  
www.wicona.it

**United Kingdom**

Silkwood Park  
Wakefield WF5 9TG  
United Kingdom  
Phone +44 845 602 8799  
www.wicona.co.uk

**Ireland**

Unit J1 Baldonnell Business Park  
Naas Road  
Dublin 22, Eire  
Phone +353 1 4105766  
www.wicona.ie

**España**

Camí de Ca n'Ametller, 18  
08195 Sant Cugat del Vallès  
Barcelona  
Teléfono +34 902 22 23 23  
www.wicona.es

**International**

270 rue Léon Joulin  
BP 63709  
31037 Toulouse cedex 01  
Téléphone +33 5 61 31 26 26  
www.wicona-int.com

**China**

5C-15 LIANDO International Industry Park,  
Maju Bridge  
Tongzhou District, Beijing, PRC 101102  
Phone +8610 6059 5686  
www.wicona.cn

**WICONA®**

W0701/07105310

[www.wicona.com](http://www.wicona.com)