

Window systems and fittings



» Why WICONA?

Because as a successful aluminium systems company based in Germany, WICONA has more than 60 years' experience – experience from which you can benefit on a daily basis. Not only are we able to fulfil the role of a reliable and cooperative supplier, but you can also enjoy the

advantages of a strong, technologically advanced brand that has enjoyed long-term success in the market. At WICONA, every detail counts: from efficient planning and processing and rapid delivery right through to active sales support. That's why WICONA!



What does WICLINE mean for metal construction?

WICLINE evo is a future-oriented further development of the successful WICLINE window series, consisting of a profile system and fittings technology that further enhances existing advantages. WICLINE evo is flexible, energy-efficient,

fast, production-friendly, process safe, variable, environmentally more responsible, cost-effective and visually attractive. WICLINE evo offers you a headstart when it comes to cost effectiveness, technology, and sustainability.

WICLINE evo – simply better	4
WICONA Unisys	
One system for all requirements	6
Sustainability	
Environmental responsibility during the entire lifecycle	8
State-of-the-art fitting technology with DPS*	10
WICSTAR evo fitting technology	11
Efficient production	12
WICPRO tooling	13
Window systems	
WICLINE 65 evo	14
WICLINE 75 evo	15
Opening types	16
Design options	18
WICLINE Series for special requirements	20
WICLINE 215 Hybrid window	21
WICLINE 125 Composite window	22
WICLINE 90SG All-glass window	23
WICTEC 50 Skylight window	24
WICLINE 65N Non-insulated window	25
WICLINE Ventilation flap	26

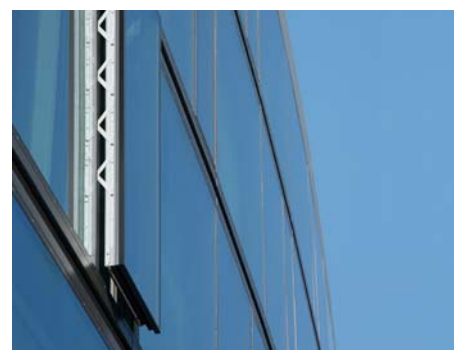

* DirectPositioningSystem

» WICLINE evo – simply better



more flexible

- All system variants for many special requirements and opening features are based on only one system technology
- Two fitting options (visible and concealed hinges), using the same production steps
- Large sashes and heavy sash weights possible

more energy efficient

- U_f values until 1.2 W/(m²K)
- U_w values until 0.87 W/(m²K) for sashes, until 0.72 W/(m²K) for fixed glazing
- First metal window certified in Switzerland as MINERGIE-P® module window

faster

- Patented corner connection system with glue injection from one side
- Unique fitting installation with DPS (DirectPositioningSystem)
- All profile processes can be punched

more production-friendly

- Integral concept using WICPRO multi punches or manual punches
- WICONA Unisys using the same components for all window as well as door or slider series
- Expertly developed components for optimal production processes

more reliable

- Fewer components and processing stages, therefore increased safety during production
- Reliable and safe price and U value calculations, design and production engineering using WICTOP Software
- High pre-fabrication level of fitting components

more flexible

- One centre seal, three installation methods: “Frame off the bobbin”, with formed corners or as complete vulcanised frame
- Large selection of profiles for all applications
- Simple upgrade (e.g. functional changes like burglar resistance or different glass types)

more environmentally friendly

- 100 % recyclable aluminium
- 68 % of the energy required to produce aluminium WICONA profiles comes from hydro-electric power
- Developed by using eco-design methods: e.g. higher insulation values while using less materials

more attractive

- Visible hinge components and handles can be anodised in all colours
- Design variation such as Classic Design, concealed sashes, large sash dimensions, and custom-made profiles can be easily achieved
- Slim, filigree design

» One system for all requirements

WICLINE 65 evo

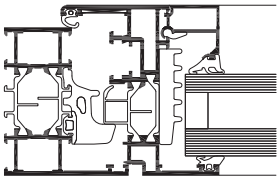

WICLINE 75 evo

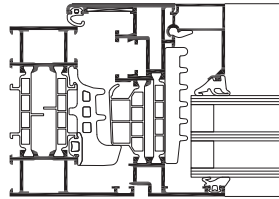

WICLINE 65 / 75 evo

Concealed sash

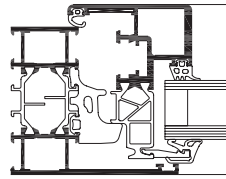

WICLINE 65 / 75 evo

Classic design

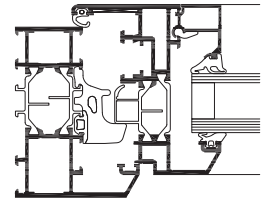

WICLINE 65 / 75 evo

Barrier free French door

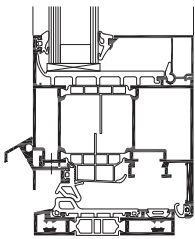

WICLINE 65 / 75 evo

Integration sash

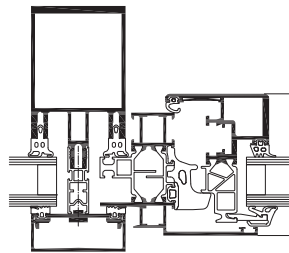

WICLINE 65 / 75 evo

Top-hung / Side-hung window

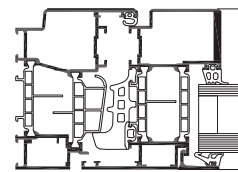

WICLINE 65 / 75 evo

Italian window

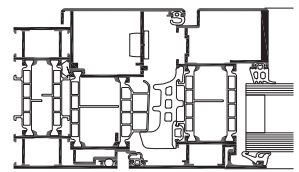

WICLINE 65 / 75 evo

Pivot window vertical / horizontal

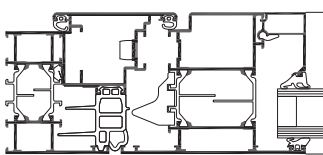

WICLINE 65 / 75 RC2

Burglar resistance

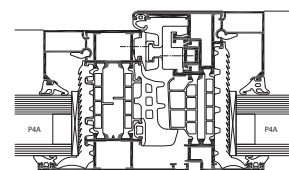

WICLINE 65 / 75 RC3

Burglar resistance

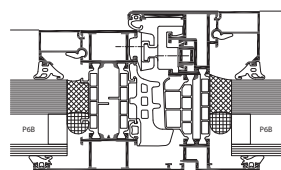

WICLINE 65 / 75 evo

Bullet resistance

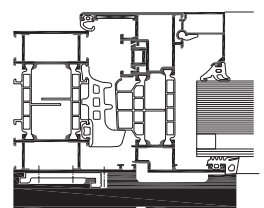

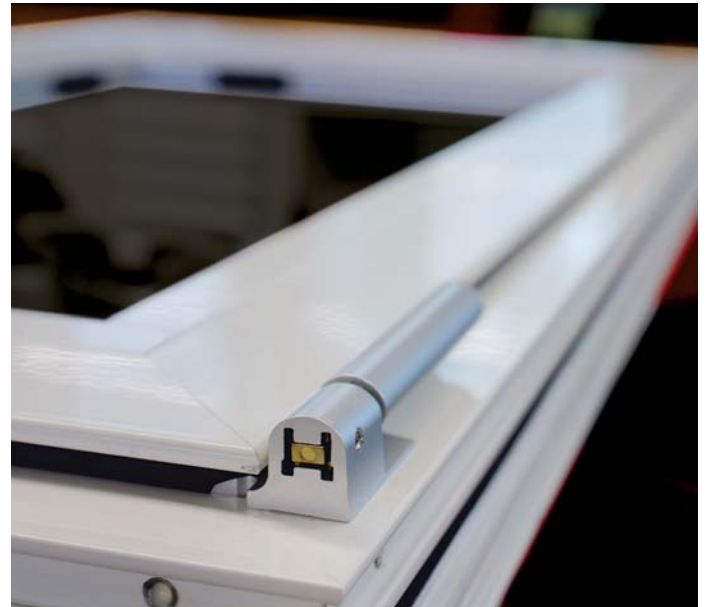

WICONA Unisys means

- Consistent modular design with identical components, e.g. same corner angles for the 65 and 75 series, and for inner and outer half shells, for special applications, and for WICSTYLE doors
- Same visual appearance for different applications such as burglar resistance, sound insulation or increased thermal insulation
- Simple adjustment for changing application, even as upgrade
- Easy planning and design with WICTOP Genius metal construction software

One hinge design, two options

- Same installation steps for fittings, either with visible or concealed hinges
- Same fitting components for 65 and 75 series
- One hinge type for sash weights up to 160 kg, for concealed fittings, up to 200 kg for visible fittings, up to 300 kg for turn sashes
- Easy planning and design with WICTOP Genius metal construction software

Your benefits

- Simplified logistics and less stock keeping
- Simple planning, easy ordering and possible adaptations until short before the production
- Less time and effort when changing sizes or designs
- Increased process reliability, due to the same manufacturing steps



» Environmental responsibility during the entire lifecycle

Here at WICONA, we target the sustainability of buildings not only through thermal insulation, but also consider energy efficiency and climate protection during the entire lifecycle of the aluminium building material. Our philosophy is the

careful management of natural resources, starting with the aluminium production using 68 % of the energy from hydro power, up to recycling processes following the "cradle to cradle" philosophy.



Aluminium production with hydro power



System development using eco-design



Recycling

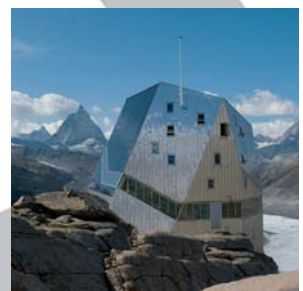

Energy-saving application



Saving energy effectively

- The intelligent system design of WICLINE evo assures U_f values up to $1.2 \text{ W}/(\text{m}^2\text{K})$ even without insulation foam
- Efficient thermal insulation, in spite of its filigree design means maximum energy-saving and optimised solar energy gains
- Triple glazing up to 69 mm is possible

Building certification made easy

Its CO_2 -saving aluminium production, thermal insulation and durability make WICLINE evo ideal for all buildings that shall be certified according to an ecolable, e.g. DGNB, BREEAM, LEED or HQE. The WICTOP Genius metal construction software provides a module for the generation of an EPD (Environmental Product Declaration).

**Extract from the Swiss MINERGIE-P[®] Certificate:
 U_w values for double casement windows until $0.8 \text{ W}/(\text{m}^2\text{K})$**

This window meets the demand of the Swiss MINERGIE-P[®] standard. A MINERGIE-P[®] window must provide the best possible technology, especially in terms of thermal insulation, condensation prevention and tightness, as well as a positive price performance ratio. WICLINE 75 evo is the first aluminium window system which received the denomination MINERGIE-P[®] module window.

Your benefits

- The demands by the architect or the builder's requirements can easily be met
- Easy to obtain building certification with EPD (Environmental Product Declaration) for the WICONA components in the WICTOP Genius software
- Exemplary durability: tomorrow's standards are already met today, changes and upgrades can be implemented at any time



Zertifikat
Wärmedurchgangskoeffizient
WICLINE 75 mit Dämmeinschub
110218.004

Gegenstand

$U_f = 1,2 \text{ W}/(\text{m}^2\text{K})$	
$U_w = 1,2 \text{ W}/(\text{m}^2\text{K})$	Glas $U_g = 1,0 \text{ W}/(\text{m}^2\text{K})$ Randverbund $\Psi_{gl} = 0,040 \text{ W}/(\text{mK})$
$U_w = 0,84 \text{ W}/(\text{m}^2\text{K})$	Glas $U_g = 0,5 \text{ W}/(\text{m}^2\text{K})$ Randverbund $\Psi_{gl} = 0,034 \text{ W}/(\text{mK})$

Fenstergröße 1,23 x 1,48 m

Grundlagen	DIN EN ISO 10077 Teil 1 und Teil 2
Uf-Wert	Infomind Flixo 6.10



» Your benefit: state-of-the-art fitting technology with DPS*





A window consists of a profile system and fittings. WICSTAR evo offers exceptional advantages.

- Fittings with visible or concealed hinges using the same fitting technology
- DPS (DirectPositioningSystem) stands for:
 - No opening of the fitting groove in the mitre
 - Fastest installation of fitting components: position, tighten, done
 - Pre-fabricated components for fast assembly and higher process reliability
 - Using clamping connections for the fitting installation, pre-drilling is not required
 - Optional usage of opening delimiter
- Highest possible quality, e.g. corrosion protection class 5 using Nanosil Technology
- Simple logistics, using environmentally friendly reusable packaging
- High sealing effect, since fittings do not penetrate or break the seals
- Installation of components at ergonomically favourable 45° angle
- A visual highlight: All visible fitting components can be anodised in colour



Your benefits

- Significant time savings during the installation of the fittings
- Increased process reliability and minimised risk of errors
- Easy implementation of the architect's demands or the developer's requirements



* DirectPositioningSystem

**Your benefit: efficient processing
in all production steps**

**WICLINE evo was developed for maximum efficiency,
process reliability, and dependable results.**

This ensures advantages during all processing steps:

- 1 | Efficient profile treatments by punch-press, using either WICPRO multi punches or manual punches
- 2 | Patented corner connection system with guided glue distribution and injection from one side only
- 3 | Three options for the centre gasket assembly:
 - New: circumferential centre seal without joint, "Frame off the bobbin"
 - New: with formed corners, without the use of cyanacrylate glue
 - With corner-vulcanised frame
- 4 | Rational fitting installation by using the DPS (DirectPositioningSystem)

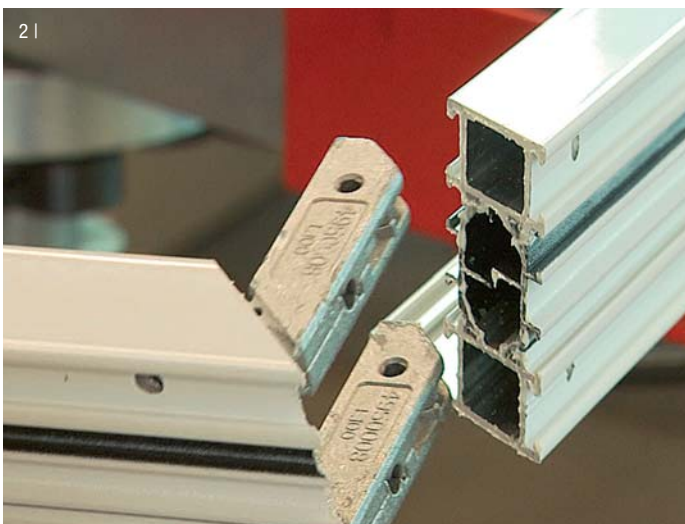

Your benefit: efficient processing in all production steps

WICPRO offers professional tools and processing equipment for all installation steps:

- Multi-punch concept (5)
- Manual punches (6)
- Turntables for easy installation (3)
- Fitting installation trolley (7)
- Reusable packages for all fittings (8)
- Adhesives, seals, foils, and much more

We offer a comprehensive program for the professional workshop.
Ask for our WICPRO catalogue.

Your benefits

- Significant time savings during all processing steps
- Reliable and high-quality results
- Minimum investments

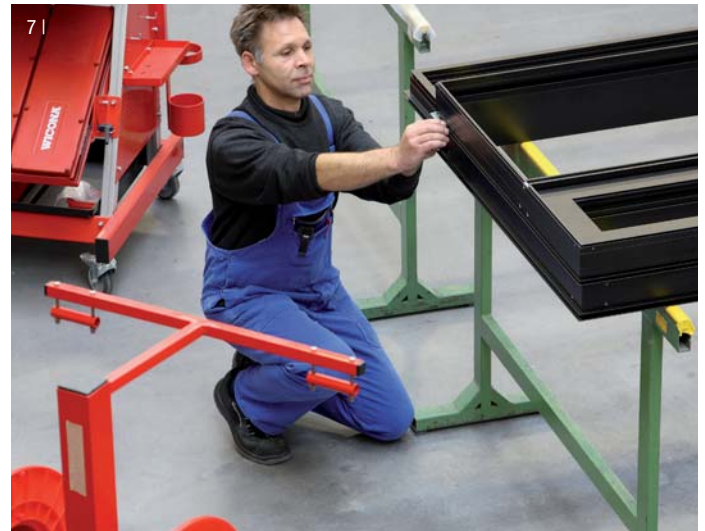
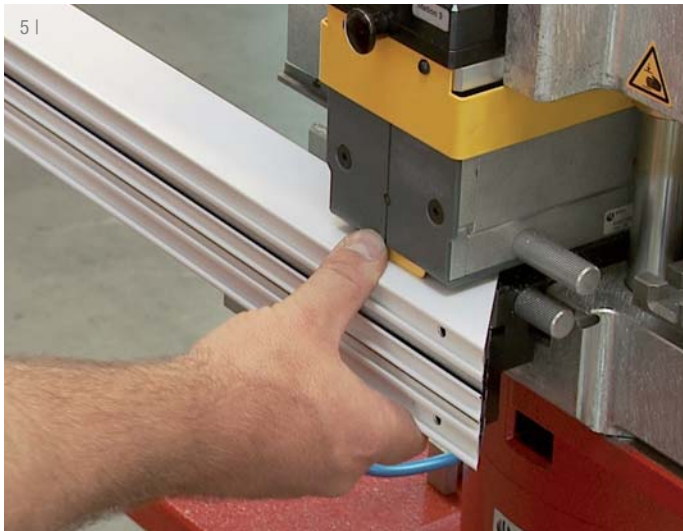

WICLINE 65 evo
Turn, turn-tilt, tilt, tilt-first,
double casement
windows / fanlights



State of the art technology and a comprehensive profile range make the aluminium window WICLINE 65 evo a perfect all-rounder with a versatile spectrum of applications. By using a design depth of only 65 mm, this system meets high standards required for thermal and sound insulation. WICLINE 65 evo offers a very attractive price/performance ratio.

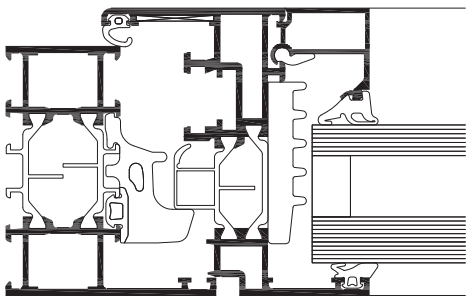

System test results / CE product pass in accordance with DIN EN 14351-1:2006+A1:2010

Air permeability:	Class 4
Watertightness:	E900
Resistance to wind load:	Class C5 / B5
Acoustic performance:	$R_w (C; C_{tr}) = 47 (-1; -4)$ dB
Operating forces:	Class 1
Load bearing capacity of safety devices:	Fulfilled
Mechanical strength:	Class 4
Repeated opening / closing:	Class 3 (20,000 cycles)
Corrosion resistance of the fittings:	Class 5
Burglar resistance:	RC1N, RC2N, RC2, RC3
Bullet resistance:	FB4 S, FB4 NS (depending on the profile combination)
Quality assurance:	Certified according to ISO 9001:2008
Environmental management:	Certified according to ISO 14001

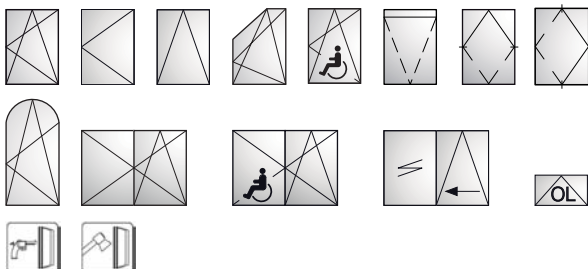

*Product data sheets for each option and opening type in PDF format from your sales office

Technical performance:

Profile technology:

- High insulation multi-chamber system in symmetric design, quality assured thermal insulator connection
- Patented corner and butt joint connection technology for high rigidity of frames and sashes
- Infill thickness up to 59 mm

Thermal insulation:

- U_f values: until 1.4 W/(m²K)
- U_w values: until 0.93 W/(m²K) with triple glazing

Sealing concept:

- Voluminous centre gasket with three installation methods:
 - Circumferential centre gasket, no joints in the corner areas
 - Formed corners, avoiding adhesive in the joints
 - Corner vulcanised frames

Fittings:

- Heavy duty system fittings with:
 - Visible hinges, powder coating or anodisation in all colours
 - Concealed hinges with integrated end position damping, opening angle max. 105°
- Sash weight:
 - Concealed fittings: up to 160 kg
 - Visible fittings: up to 200 kg
 - On demand: up to 300 kg
- Sash sizes (w x h): 1700 mm x 2500 mm, fanlight 2500 mm x 1700 mm
- Optionally with opening limiter in various executions

Additional designs:

- Concealed sash
- Classic design
- Integration frame for stick façades
- Fanlight with hand lever, cranked rod or motor
- Pivot window, horizontal or vertical
- Parallel sliding window, with or without force operation
- Italian style window
- Top-hung window
- Window doors with barrier free threshold, single or double casement door, inward and outward opening
- Burglar resistance (see system tests)
- Bullet resistance (see system tests)

Compatible with the door series
WICSTYLE 65 evo and WICSTYLE 75 evo

WICLINE 75 evo
Turn, turn-tilt, tilt, tilt-first,
double casement windows /
fanlights / MINERGIE-P[®] module



With 75 mm profile depth, WICLINE 75 evo features the highest thermal insulation properties and structural characteristics. With its superior technical performance this aluminium window is attuned to all architectural requirements of the future. In Switzerland WICLINE 75 evo has been the first metal window to be certified as MINERGIE-P[®] module window.

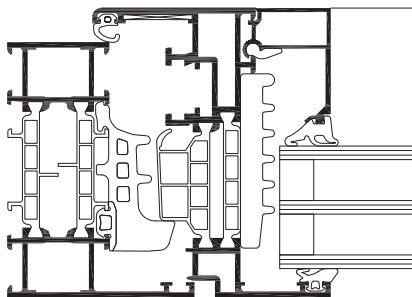

System test results / CE product pass in accordance with DIN EN 14351-1:2006+A1:2010

Air permeability:	Class 4
Watertightness:	E900
Resistance to wind load:	Class C5 / B5
Acoustic performance:	$R_w (C; C_{tr}) = 47 (-1; -4)$ dB
Operating forces:	Class 1
Load bearing capacity of safety devices:	Fulfilled
Mechanical strength:	Class 4
Repeated opening / closing:	Class 3 (20,000 cycles)
Corrosion resistance of the fittings:	Class 5
Burglar resistance:	RC1N, RC2N, RC2, RC3
Bullet resistance:	FB4 S, FB4 NS (depending on the profile combination)
Quality assurance:	Certified according to ISO 9001:2008
Environmental management:	Certified according to ISO 14001

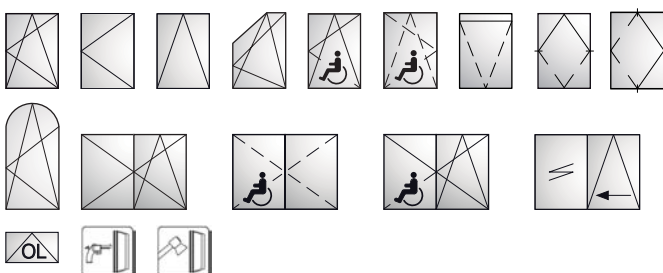

*Product data sheets for each option and opening type in PDF format from your sales office

Technical performance:

Profile technology:

- High insulation multi-chamber system in symmetric design, quality assured thermal insulator connection
- Patented corner and butt joint connection technology for high rigidity of frames and sashes
- Infill thickness up to 69 mm

Thermal insulation:

- U_f values: until 1.2 W/(m²K)
- U_w values: until 0.87 W/(m²K) for sashes, until 0.72 W/(m²K) for fixed glazing, with triple glazing
- Certified as MINERGIE-P[®] module $U_w \leq 0.8$ W/(m²K)

Sealing concept:

- Voluminous centre gasket with three installation methods:
 - Circumferential centre gasket, no joints in the corner areas
 - Formed corners, avoiding adhesive in the joints
 - Corner vulcanised frames

Fittings:

- Heavy duty system fittings with:
 - Visible hinges and fittings, powder coating or anodisation in all colours
 - Concealed hinges with integrated end position damping, opening angle max. 105°
- Sash weight:
 - Concealed fittings: up to 160 kg
 - Visible fittings: up to 200 kg
 - On demand: up to 300 kg
- Sash sizes (w x h): 1700 mm x 2500 mm, fanlight 2500 mm x 1700 mm
- Optionally with opening limiter

Additional designs:

- Concealed sash
- Classic design
- Integration frame for stick façades
- Fanlight with hand lever, cranked rod or motor
- Pivot window, horizontal or vertical
- Parallel sliding window, with or without force operation
- Italian style window
- Top-hung window
- Window doors with barrier free threshold, single or double casement door, inward and outward opening

Compatible with the door series
WICSTYLE 65 evo and WICSTYLE 75 evo

Opening types

1 | Turn / turn-tilt / tilt windows / fanlights

With 65 mm or 75 mm profile depth, WICLINE evo features the highest thermal insulation properties and structural characteristics. With its superior technical performance this aluminium window is attuned to all architectural requirements of the future.

2 | Pivot windows (vertical / horizontal)

A classic opening type becomes again a state-of-the-art product with WICONA technology: The horizontal and the vertical pivot windows based on the aluminium window system WICLINE evo offer improved thermal insulation, have achieved high classifications in CE-testing each, and with their option of visible or concealed fittings they are a real visual highlight for any punched or façade integrated window.

3 | Parallel sliding tilt window PSK

In this space saving opening version the sash can be tilted or slid away to the side with ease. High operation comfort, versatile ventilation positioning without disturbing sash and the elevated technical performance values are characteristic for this opening type of the WICLINE evo aluminium window system.

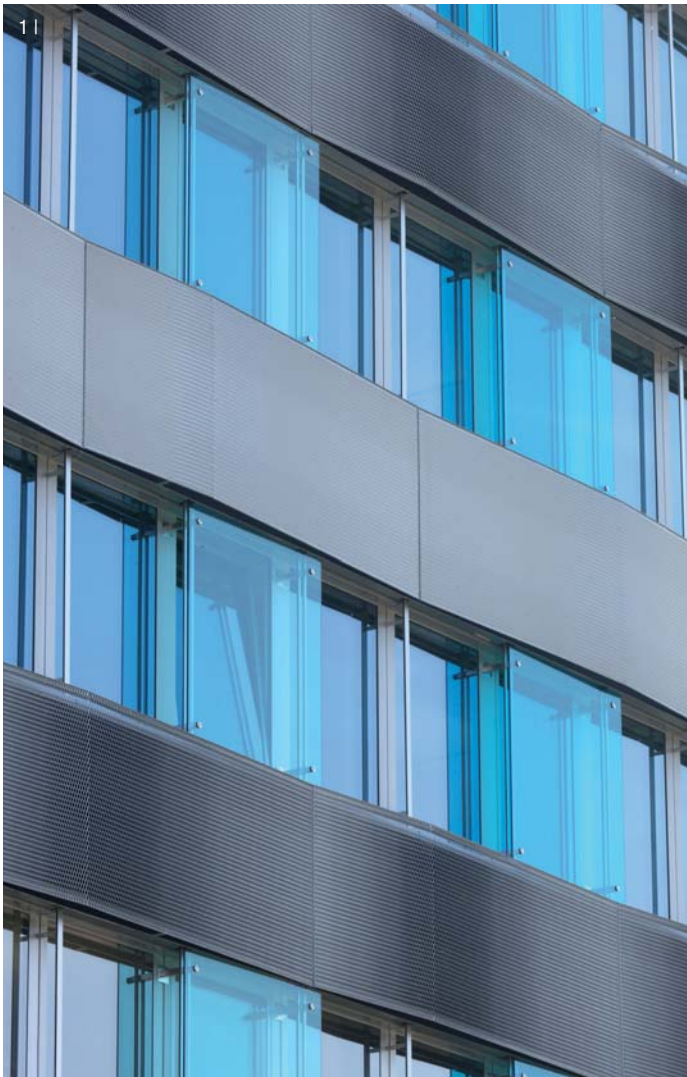

Opening types

4 | Top-hung / side-hung / Italian style windows

The outward opening function frequently offers substantial benefits: efficient ventilation, no disturbing sash in the room, manual or motorised operation. With its very large sash formats and optimised functions WICLINE evo features in this option a more than interesting alternative for architecture.

5 | Ventilation flap

With a thermally insulated aluminium turn sash for integration into stick façades, the WICLINE evo ventilation flap meets the frequent requirement for a manually or motor operated ventilation, adapted for perfect visual integration into the curtain wall.

6 | Smoke windows (SHEV)

Several window types with approval for curtain wall and skylight for a wide range of applications:

- For facades and glass roofs
- Opening inward or outward
- Can also be used as vent sashes
- Tested and approved as complete system
- Very good aerodynamic data and flow coefficients thanks to large opening angle
- Types of opening:
 - Tilt sash windows, opening inwards and outwards
 - Turn sash windows, opening inwards and outwards
 - Top-hung sashes (opening to the outside)
 - Flush top-hung sashes (opening to the outside)
 - Skylights (opening to the outside)

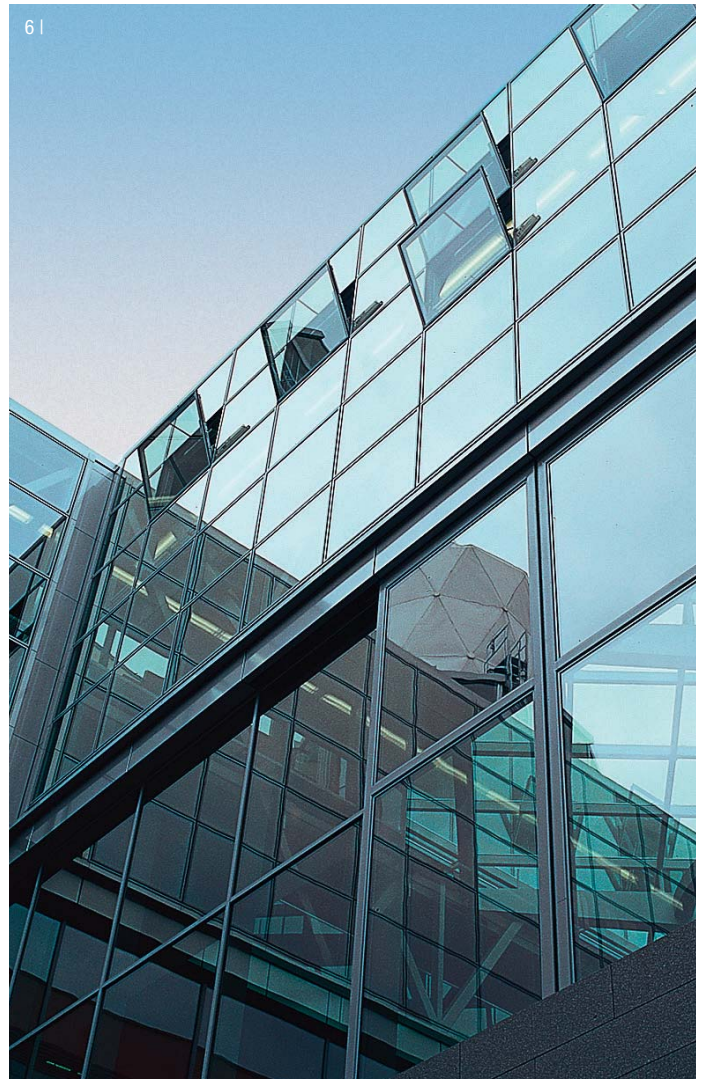
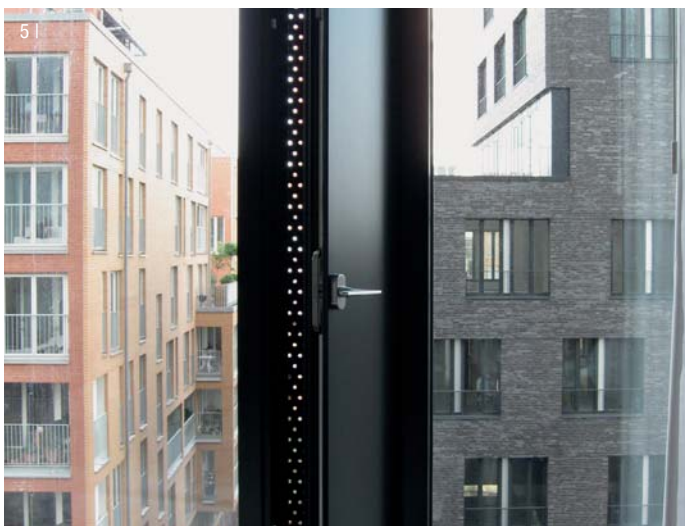

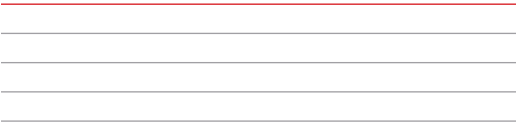

Design options

WICLINE evo design options

Based on the unique WICONA Unisys technology with a wide range of different profile contours the WICLINE evo windows in both construction depths, 65 mm and 75 mm, can easily be adapted to individual design requirements. The performances, functions and opening types remain on the highest technical level.

11



Design options

1 | MINERGIE-P® window

With superior thermal insulation $U_w \leq 0.8 \text{ W/(m}^2\text{K)}$

2 | Concealed sash

Extremely slim frame for maximum light transmission and panoramic views. Very good U_w values due to optimised frame-glass ratio.

3 | Classic design

Bevelled profile contours and overlapping sashes offer a design which suits especially to residential properties.

4 | Integration sash

The ideal extension for all stick system or unitised curtain walls, available as standard or concealed sash.

5 | Barrier free threshold

Ideal for large format window doors:

A barrier free and thermally insulated threshold can be executed in sashes with a size up to 1.3 m x 2.5 m (inward opening) and 1.1 m x 2.25 m (outward opening)



» Tried and tested series for special requirements

The comprehensive application spectrum and high-quality performance of the new WICLINE evo series meet the demands of the market and most of the newest standards. By using only two profile depths, most challenges in

modern metal construction work can be solved at the highest level. For all other special requirements, the WICLINE product range offers the right solution.



WICLINE 215
Hybrid window
with double skin technology



High sound insulation even when the window is open?
 WICONA has found a solution for an issue that at first appears irresolvable – the WICLINE 215. A double pane window with the same structural and physical values of a double skin façade. This new type of window combines an inward opening sash with a parallel projecting sash. Both can be operated independently. This construction multiplies the user comfort in many ways: individual ventilation, and automatic control for night cooling assure the best possible room climate. A sun protection device integrated between both sashes not only ensures even greater comfort, it also reduces energy consumption.

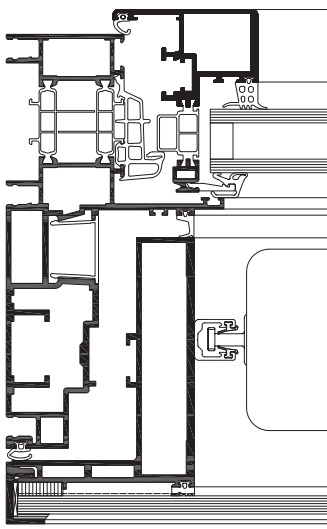

System test results/CE product pass in accordance with DIN EN 14351-1:2006+A1:2010

WICLINE 215 is a bespoke solution which is adapted to each individual project requirement. The respective needs are considered in the project specific testing. For further information and personal project support please contact your WICONA sales office.

Technical performance:

System technology:

- Hybrid window in double skin technology, with all its advantages: interior manual or automatised sash, exterior parallel outward opening sash
- Two sashes that can be operated individually, no restrictions in use
- Integrated sun shading device, protected against high wind speeds, dirt and weathering
- Only 215 mm system depth, despite integrated solar protection, motor assistance and control system
- Inner sash protected from burglary or weathering even when outer window is open

Thermal insulation:

- U_w values until $0.65 \text{ W}/(\text{m}^2\text{K})$ are feasible

Sound insulation:

- Superior sound insulation level with closed sashes, depending on the glazing; increased sound insulation already with open exterior and interior sash
- In combination with sound insulation glazing a protection level of 57 dB can be achieved

Fittings:

- Interior sash with following options: turn / turn-tilt / tilt / double casement / E-TecDrive / fanlight / burglar resistance / night cooling
- Exterior sash with motorised parallel outward opening operation

WICLINE 125
Coupled window



WICLINE 125 is a composite window system for buildings with particularly high thermal and sound insulation requirements. The interior sash is combined with an additional sash in front of it. This significantly increases the window's protective features, thermal performance and living comfort. Sun shading systems can be integrated in a weather protected way between the outer and inner sash.

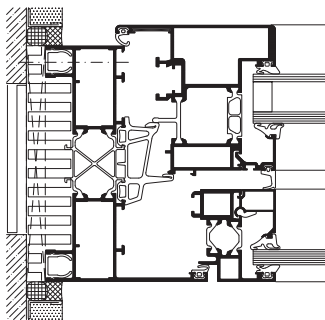

System test results / CE product pass in accordance with DIN EN 14351-1:2006+A1:2010

Air permeability:	Class 4
Watertightness:	E750
Resistance to wind load:	Class C5 / B5
Acoustic performance:	$R_w (C;C_{tr}) = 48 (-1;-4)$ dB
Operating forces:	Class 1
Burglar resistance:	Until WK3
Quality assurance:	Certified according to ISO 9001:2008
Environmental management:	Certified according to ISO 14001



Technical performance:

Profile technology:

- Profile depths:
 - 125 mm: Frame and transom profiles
 - 136 mm: Combined sash profiles, main inner sash with overlap
- Between the two sashes a sunshade device can be integrated, protected from any weather influence and wind speeds

Thermal insulation:

- U_w values below 0.9 W/(m²K)

Sound insulation:

- Sound insulation up to 48 dB

Burglar resistance:

- Resistance classes from WK1 to WK3 in accordance with DIN V ENV 1627 can be achieved

Fittings:

- Permitted sash weight (total for combined windows) up to 160 kg – turn, turn-tilt, tilt window / fanlight

Optional designs:

- Outer sash – with thermal insulation
- Outer sash – concealed design
- Outer sash – industrial design
- Outer sash – all-glass window, glued



WICLINE 90SG
Structural glazing integration sash
Italian sash / parallel
outward opening sash



As an attractive complement for curtain walls the integration sash WICLINE 90SG provides efficient ventilation, if requested also fully automated.

This all-glass sash window gives full options as a projecting top-hung sash or as a parallel outward opening sash and can be integrated flush with the glass pane level in WICTEC 50SG structural glazing curtain walling or in stick systems with exterior pressure profiles. For an optimum thermal insulation WICLINE 90SG can be equipped with double or triple glazing. Using standard glass without glass step leads to an economy of cost and improved safety.

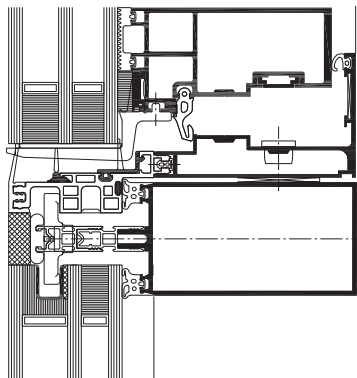

System test results / CE product pass in accordance with DIN EN 14351-1:2006+A1:2010

Air permeability:	Class 4
Watertightness:	E750
Resistance to wind load:	Class C4 / B4
Repeated opening / closing:	Class 2 (10,000 cycles)
Impact resistance:	Class 3
Load bearing capacity of safety devices:	Fulfilled
Approval:	ETA (European Technical Approval)
Quality assurance:	Certified according to ISO 9001:2008
Environmental management:	Certified according to ISO 14001

Technical performance:

Profile technology:

- All-glass sash with slim profile design for maximum transparency and finelined window structures. Construction depth 90 mm, interior width 55 mm
- ETA granted (European Technical Approval)
- Infill thickness up to 62 mm
- For double or triplex glass
- Technology without step glazing, leading to economy and simpler assembly
- Complete fittings from WICONA for manual or motor operation

Thermal insulation:

- U_f value until 1.1 W/(m²K)

Italian sash application:

- Sash weight until 180 kg
- Sash formats (w x h): until 1500 mm x 2500 mm or until 2000 mm x 1700 mm

Parallel outward sash application:

- Sash weight until 200 kg
- Sash formats (w x h): until 1500 mm x 3000 mm or until 2000 mm x 1500 mm



WICTEC 50
Integration sash
Skylight window

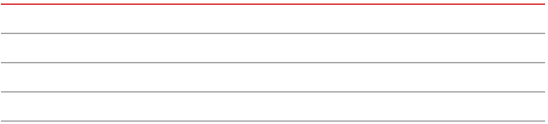

The quality requirements for ventilation sashes are particularly high for those installed in the roof. WICTEC 50 meets these requirements and delivers a delicate appearance with minimal offset of the glass level. Minimised profile widths, concealed hinges with 90° opening angle and the option of large sash formats offer extensive freedom of design. Thanks to the large ventilation cross sections, the WICTEC 50 skylight is also ideal for use as natural smoke and heat exhaust ventilators.

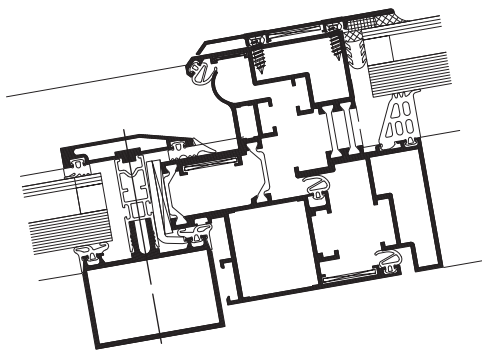

System test results / CE product pass in accordance with DIN EN 14351-1:2006+A1:2010

Air permeability:	Class 4
Watertightness:	9A
Resistance to wind load:	Class C5 / B5
Quality assurance:	Certified according to ISO 9001:2008
Environmental management:	Certified according to ISO 14001



Technical performance:

Profile technology:

- High insulation triple-chamber system, quality assured thermal insulator connection
- Slim design with only 81 mm visible sight line
 - Offset against the glass only 36 mm
 - Application in sloped glazing until 10°

Fittings:

- Concealed turn hinges
 - Opening angle 90°
 - Manual or motorised operation

Sash weight:

- Until 130 kg
- Sash formats (w x h): until 1800 mm x 1400 mm or until 1400 mm x 1800 mm

Additional options:

- NSHEV: tested and approved as natural smoke and heat extraction ventilation unit.



WICLINE 65N
Non-insulated windows



The WICLINE 65N aluminium window is ideally suited for buildings in which specific heat protection measures are unnecessary. Ideal as well for the use as NSHEV (Natural smoke and heat extraction equipment).

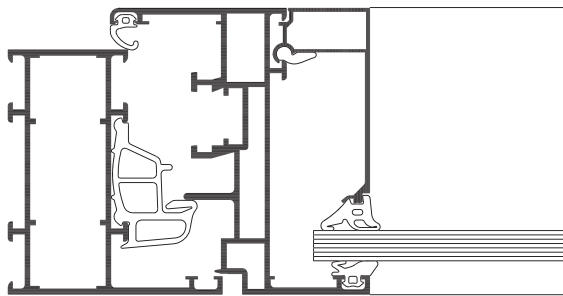

System test results / CE product pass in accordance with DIN EN 14351-1:2006+A1:2010

Air permeability:	Class 4
Watertightness:	9A
Resistance to wind load:	Class C5 / B5
Operating forces:	Class 1
Repeated opening / closing:	Class 2 (10,000 cycles)
Burglar resistance:	WK1, WK2
Quality assurance:	Certified according to ISO 9001:2008
Environmental management:	Certified according to ISO 14001



Technical performance:

Profile technology:

- High quality aluminium profiles, without thermal break
- Patented corner and butt joint connection technology for high rigidity of frames and sashes
- Infill thickness up to 58 mm

Fittings:

- Concealed single-handed operated fittings, alternatively with:
 - visible hinges
 - concealed hinges
- Sash weight:
 - Up to 100 kg
- Sash sizes (w x h): 1300 mm x 1700 mm

Additional designs non-insulated:

- Window-doors/French doors
- NSHEV applications
- Burglar resistance

Compatible with the door series WICSTYLE 65N non-insulated

WICLINE 75 evo Ventilation flap

With a thermally insulated aluminium turn sash for integration into stick façades or window constructions, the WICLINE evo ventilation flap meets the frequent requirement for a manually or motor operated ventilation, adapted for perfect visual integration into the curtain wall.

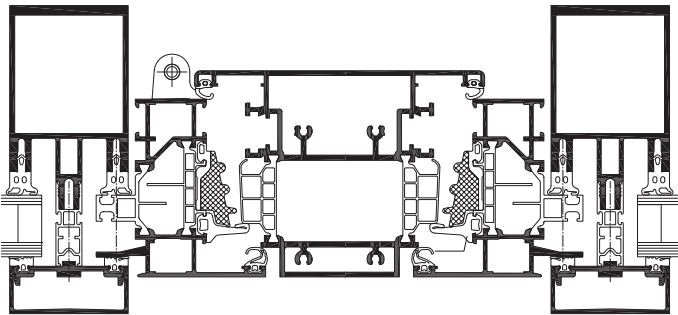

WICLINE 75 evo ventilation flap 250

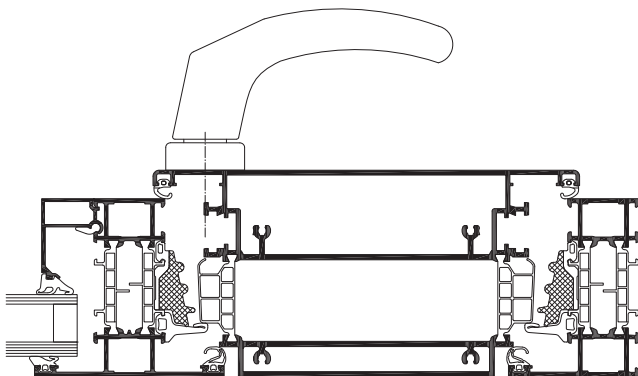

WICLINE 75 evo ventilation flap 180



Technical performance:

System technology:

- High insulation turn sash with 180 mm or 250 mm visible width
- System depth 75 mm, sash depth 87 mm
- Profiles prepared for full motor integration
- Slim, homogeneous design
- Profile processing by 90° cutting saw or notch cuts
- Centre gasket on all four sides with formed corners

Thermal insulation:

- U_f value stepwise adaptable until 1.2 W/(m²K)

Fittings:

- Manual operation:
 - Visible hinges and fittings, powder coated or anodised, for sash width 250 mm
 - Concealed hinges with integrated end position damping for sash width 180 mm and 250 mm
- Fully integrated motor drive (on demand):
 - With visible turn hinges
 - No motor chains
 - Adjustable opening angle
 - Control by switch, remote or central control
- Sash weight: 80 kg
- Sash sizes (w x h): 180 mm x 3000 mm or 250 mm x 3000 mm
- Optionally opening limiter for visible hinges, integrated for concealed fittings



**Austria**

5201 Seekirchen
 ☎ +43 6212 2000
 ✉ info@wicona.at

Benelux

2260 Oevel
 ☎ +32 14 249999
 ✉ info@wicona.be
 ✉ info@wicona.nl

Czech Republic

63900 Brno
 ☎ +420 543 422030
 ✉ info@wicona.cz

Denmark

7430 Ikast
 ☎ +45 7020 2048
 ✉ info@wicona.dk

España

08195 Sant Cugat del Vallès
 Barcelona
 ☎ +34 902 222323
 ✉ info@wicona.es

Estonia / Latvia / Lithuania

11317, Tallinn
 ☎ +37 2657 6635
 ✉ info@wicona.lt

France

02200 Courmelles
 ☎ +33 3 23598200
 ✉ info@wicona.fr

94388 Bonneuil-sur-Marne Cedex
 ☎ +33 1 45138000

Germany

89077 Ulm
 ☎ +49 731 3984-0
 ✉ info@wicona.de

47051 Duisburg
 ☎ +49 203 45046-0

04315 Leipzig
 ☎ +49 341 989795-0

64646 Heppenheim
 ☎ +49 6252 6736-0

Hungary

1031 Budapest
 ☎ +36 (1) 4533457
 ✉ info@wicona.hu

Ireland

Dublin 22, Eire
 ☎ +353 1 4105766
 ✉ info@wicona.ie

Italia

20063 Cernusco sul Naviglio MI
 ☎ +39 02 924291
 ✉ info@wicona.it

Norway

0283 Oslo
 ☎ +47 22 422200
 ✉ info@wicona.no

Poland

03-828 Warszawa
 ☎ +48 22 3308170
 ✉ info@wicona.pl

Russia

123995, Москва
 ☎ +7 495 207-75-30
 ✉ info@wicona.ru

Sweden

352 45 Växjö
 ☎ +46 470 787400
 ✉ info@wicona.se

Switzerland

5506 Mägenwil
 ☎ +41 62 88741-41
 ✉ info@wicona.ch

United Kingdom

Wakefield WF5 9TG
 ☎ +44 845 6028799
 ✉ info@wicona.co.uk

Africa / Asia / America

31037 Toulouse
 ☎ +33 5 61312626
 ✉ info@wicona-int.com

China

Tongzhou District, Beijing, PRC 101102
 ☎ +8610 60595686
 ✉ info@wicona.cn

Qatar

Doha
 ☎ +974 44 912552
 ✉ info@wicona-int.com

WICONA®



www.wicona.com